

DM Food Packaging Catalogue



Kitchenware

Food Packaging

Tissue Paper

One Stop Solutions

www.dmhygiene.com.my



Debonair Marketing

Care hotline: 018 666 0642

CONTENT

	ITEMS	PAGES
A	CONTAINER	5 - 18
B	STRAW	19 - 20
C	CUPS & LIDS , PET ROUND BOTTLE	21 - 25
D	PAPER CUP , PAPER HOT CUP, CUP SLEEVE, PULP PAPER CUPS HOLDER, NON-WOVEN PAPER CHEF CAP, PAPER BAG , PAPER BOWL SERIES , PAPER PLATE, HAWKER PAPER	26 - 31
E	LUNCH BOX, PIZZA BOX, STRING ROLL	31 - 32
F	SPOON, FORK & KNIFE	33 - 37
G	RUBBER BAND, TOOTHPICK, BAMBOO CHOPSTICK, BAMBOO SKEWER, TEPPO SKEWER	38 - 39
H	FOOD WRAP FILM, CATERING FILM , ALUMINIUM FOIL, BAKING PAPER, IVORY PAPER DOILY, CHINESE STEAMER PAPER	40 - 43
I	ZIPLOCK BAG, NYLON BAG, NYLON EMBOSSED BAG, LDPE PLASTIC NAG, HM PLASTIC BAG, T-SHIRT BAG, PE-T-SHIRT BAG, BAG ON ROLL, GARBAGE BAG	44 - 52
J	HYGIENE PRODUCTS LIST, SMALL TOILET ROLL, THERMAL PAPER ROLL, DISPOSABLE HAND GLOVES, PERSONAL PROTECTIVE EQUIPMENT	53 - 59
K	ACRYLIC	60 - 62
L	GASTRONORM PAN (GN PAN)	63 - 75
M	WOODEN PRODUCTS, GLASS WARE	76 - 81

	ITEMS	PAGES
N	STAINLESS STEEL PRODUCTS, STAINLESS STEEL SPARK-L , MEAT SLICER WITH STAINLESS STEEL BLADE, STAINLESS STEEL POT, PAN AND SPAREPARTS SERIES	82 – 115
O	NON-STICK HONEYCOMB & FRYING PAN, CAPATI PLATE, HOT PLATE	116 – 121
P	ALUMINIUM PRODUCTS, CARBON STEEL WOK, CLAY POT, SALT POT, CHARCOAL STOVE	122 – 129
Q	BAMBOO PRODUCTS, MULTI- PURPOSE COTTON STEAMER CLOTH, MULTI- PURPOSE COOKING BAG, COTTON SOYA MILK BAG , NON-STICK RICE COOKER MAT	130 – 136
R	CUTLERY SERIES, CHICKEN BOWL, PLATE, TEA CUP & TEA POT, SEASONING DISH SERIES	137 – 149
S	KNIFE, SCISSORS, CHOPPING BOARD, SHARPENING STONE, WHETSTONE SERIES, KNIFE SHARPENER	150 – 166
T	CAN OPENER, VEGETABLE CUTTER, PEELER & GRATER	167 – 170
U	ICE CREAM SCOOP, PIZZA PLATE (COATING), PIZZA SUPPLIES, TURNER, SPATULA	171 – 177
V	FOOD TONG, LOCKING TONG, CHAFING DISH, COFFEE SERVER, COFFEE DECANTER & WARMER	178 – 184
W	STOVE & COOKING EQUIPMENTS , COMMERCIAL MACHINE, DISPENSER, COOLER/BOILER, ELECTRIC SOUP WARMER	185 – 193
X	CAMRY SCALE, DIGITAL SCALE & ITEMS	194 – 197
Y	BAR	198 – 218
Z	MISCELLANEOUS PRODUCTS, COLLECTOR & SERVING TROLLEY, RUBBISH BIN, BROOM & DUSTPAN , MOP & WIPER, FLOOR CLEANING, VIP HANDTRUCK	219 – 244

FOOD PACKAGING & DISPOSABLE PRODUCTS





ROUND CONTAINER

A-06-01(FC 90)



SIZE : L77x W77x H40mm
 PACKING : 50PCS /PKT
 PACKING : 10 PKT/ CTN

A-06-02(FC 190)



SIZE : L77 x W77 x H78mm
 PACKING : 50PCS /PKT
 PACKING : 10 PKT/ CTN

A-06-03(FC 200)



SIZE : L95 x W95 x H56mm
 PACKING : 50PCS /PKT
 PACKING : 10 PKT/ CTN

A-06-04(FC 250)



SIZE : L120 x W120 x H40mm
 PACKING : 50PCS/PKT
 PACKING : 10 PKT/ CTN

A-06-05(FC 12)



SIZE : L120 x W120 x H56mm
 PACKING : 50PCS/PKT
 PACKING : 10 PKT/ CTN

A-06-06(RT-300-R)



SIZE : L120 x W120 x H65mm
 PACKING : 50PCS /PKT
 PACKING : 10 PKT/ CTN

A-06-07(FC 20)



SIZE : L120 x W120 x H85mm
 PACKING : 50PCS /PKT
 PACKING : 10 PKT/ CTN

A-06-08(FC 25)



SIZE : L120 x W120 x H92mm
 PACKING : 50PCS /PKT
 PACKING : 10 PKT/ CTN

A-06-09
 (FC 30)



SIZE : L120 x W120 x H109mm
 PACKING : 50PCS /PKT
 PACKING : 10 PKT/ CTN

A-07-01(RT – 750R)



SIZE : L150 x W150 x H68mm
PACKING : 50PCS/PKT
PACKING : 5PKT/ CTN

A-07-02(FC1000B)



SIZE : L150 x W150 x H77mm
PACKING : 50PCS/PKT
PACKING : 5PKT/ CTN

A-07-03(RT1000R)



SIZE : L150 x W150 x H96mm
PACKING : 50PCS /PKT
PACKING : 5PKT/ CTN

A-07-04(FC1500)



SIZE : L150 x W150 x H114mm
PACKING : 30PCS/PKT
PACKING : 6PKT/ CTN

A-07-05(FC1800)



SIZE : L150 x W150 x H189mm
PACKING : 30PCS /PKT
PACKING : 6PKT/ CTN

A-07-06(FC2300)



SIZE : L182 x W182 x H121mm
PACKING : 25PCS /PKT
PACKING : 6PKT/ CTN

A-07-07(FC2500)



SIZE : L237 x W237 x H71mm
PACKING : 30PCS/PKT
PACKING : 4PKT/ CTN

A-07-08(FC3000)



SIZE : L237 x W237 x H120mm
PACKING : 30PCS /PKT
PACKING : 3PKT/ CTN



A-08-01(MS 2)



SIZE : W 75 x H 25mm
PACKING : 100PCS /PKT
PACKING : 10PKT/ CTN

BLACK ROUND CONTAINER WITH LID



R-12



R-16

- **A-08-02** – Capacity : 12 oz PACKING : 10PCS/PKT
- **A-08-03**– Capacity : 16 oz PACKING : 10PCS/PKT

ROUND DISPOSABLE PLASTIC FOOD CONTAINER HINGED

LID



- **A-08-04** – Capacity : **1 OZ**
PACKING : 100PCS/PKT (30PKT/CTN)
- **A-08-05** – Capacity : **2 OZ**
PACKING : 50PCS/PKT (20PKT/CTN)
- **A-08-06** – Capacity : **2.5 OZ**
PACKING : 50PCS/PKT (20PKT/CTN)
- **A-08-07** – Capacity : **3.25 OZ**
PACKING : 50PCS/PKT (12PKT/CTN)
- **A-08-08** – Capacity : **4 OZ**
PACKING : 50PCS/PKT (12PKT/CTN)

SQUARE CONTAINER



A-09-01(RT – 250S)



SIZE : L102 x W102 x
H45mm
PACKING : 50PCS /PKT
PACKING : 10PKT/ CTN

A-09-02(FSQ 350)



SIZE : L115 x W115 x
H48mm
PACKING : 50PCS /PKT
PACKING : 10PKT/ CTN

A-09-03(FSQ 450)



SIZE : L115 x W115 x
H58mm
PACKING : 50PCS /PKT
PACKING : 10PKT/ CTN

A-09-04(FSQ 550)



SIZE : L115 x W115 x
H69mm
PACKING : 50PCS /PKT
PACKING : 10PKT/ CTN

A-09-05(FSQ 650)



SIZE : L135 x W135 x
H65mm
PACKING : 50PCS /PKT
PACKING : 10PKT/ CTN

A-09-06(FSQ 750)



SIZE : L135 x W135 x
H73mm
PACKING : 50PCS /PKT
PACKING : 10PKT/ CTN

A-09-07(FSQ 1000)



SIZE : L161 x W161 x
H55mm
PACKING : 50PCS /PKT
PACKING : 6PKT/ CTN

A-09-08(FSQ 1500)



SIZE : L164 x W164 x
H74mm
PACKING : 50PCS /PKT
PACKING : 6PKT/ CTN

A-09-09(FSQ 2000)



SIZE : L164 x W164 x
H106mm
PACKING : 50PCS /PKT
PACKING : 6PKT/ CTN

A-09-10(FS 2000)



SIZE : L203 x W203 x
H72mm
PACKING : 30PCS /PKT
PACKING : 3PKT/ CTN

A-09-11(FS 3000)



SIZE : L203 x W203 x
H100mm
PACKING : 30PCS /PKT
PACKING : 3PKT/ CTN

RECTANGULAR CONTAINER



A-10-01(FR500)



SIZE : L173 x W122 x
H32mm
PACKING : 50PCS /PKT
PACKING : 5PKT/ CTN

A-10-02(FR650)



SIZE : L173 x W122 x
H43mm
PACKING : 50PCS /PKT
PACKING : 5PKT/ CTN

A-10-03(FR750)



SIZE : L173 x W122 x
H48mm
PACKING : 50PCS /PKT
PACKING : 5PKT/ CTN

A-10-04(FR1000)



SIZE : L173 x W122 x
H62mm
PACKING : 50PCS /PKT
PACKING : 5PKT/ CTN

A-10-05(RT-500S)



SIZE : L173 x W122 x
H37mm
PACKING : 50PCS /PKT
PACKING : 5PKT/ CTN

A-10-06(RT-650S)



SIZE : L173 x W122 x
H48mm
PACKING : 50PCS /PKT
PACKING : 5PKT/ CTN

A-10-07(RT-750S)



SIZE : L173 x W122 x
H54mm
PACKING : 50PCS /PKT
PACKING : 5PKT/ CTN

A-10-08(RT-1000S)



SIZE : L173 x W122 x
H71mm
PACKING : 50PCS /PKT
PACKING : 5PKT/ CTN

A-10-09(RT-1500S)



SIZE : L204 x W152 x
H76mm
PACKING : 50PCS /PKT
PACKING : 5PKT/ CTN

A-10-10(FR 1300)



SIZE : L173 x W122 x
H86mm
PACKING : 50PCS /PKT
PACKING : 5PKT/ CTN



A-11-01(MS 850BS)



SIZE : L221 x W151 x H35mm
 PACKING : 50PCS /PKT
 PACKING : 6PKT/ CTN



A-11-02(MS 1300L)



SIZE : L254 x W121 x H60mm
 PACKING : 50PCS /PKT
 PACKING : 6PKT/ CTN



A-11-03(MS 1800A)



SIZE : L279 x W198 x H45mm
 PACKING : 50PCS /PKT
 PACKING : 4PKT/ CTN

RECT.CONTAINER WITH LID



- **A-11-04** BLACK-R500 – Capacity : **500cc**
 PACKING : **50PCS/PKT (5PKT/CTN)**
- **A-11-05** BLACK-R650 – Capacity : **650cc**
 PACKING : **50PCS/PKT (5PKT/CTN)**
- **A-11-06** BLACK-R750 – Capacity : **750cc**
 PACKING : **50PCS/PKT (5PKT/CTN)**
- **A-11-07** BLACK-R1000 – Capacity : **1000cc**
 PACKING : **50PCS/PKT (5PKT/CTN)**

COMPARTMENTAL CONTAINER



A-12-01(FR 750-2C)



SIZE : L173 x W122 x H55mm
PACKING : 50PCS /PKT
PACKING : 5PKT/ CTN

A-12-02(FR1000-2C)



SIZE : L173 x W122 x H66mm
PACKING : 50PCS /PKT
PACKING : 5PKT/ CTN

A-12-03(RT-1100R-3C)



SIZE : L220 x W220 x H54mm

A-12-04(RT-1200S-3)



SIZE : L220 x W192 x H45mm

A-12-05(FR-1200S-3C)



SIZE : L206 x W187 x H42mm

A-12-06(RT-1400S-4C)



SIZE : L257 x W190 x H50mm

A-12-07(RT-1400S-5C)



SIZE : L266 x W205 x H37mm



A-13-01(MS 750D)



SIZE : L171 x W122 x H59mm
PACKING : 50PCS /PKT
PACKING : 10PKT/ CTN



A-13-02(MS 1200TC)



SIZE : L227 x W177 x H45mm
PACKING : 50PCS /PKT
PACKING : 6PKT/ CTN

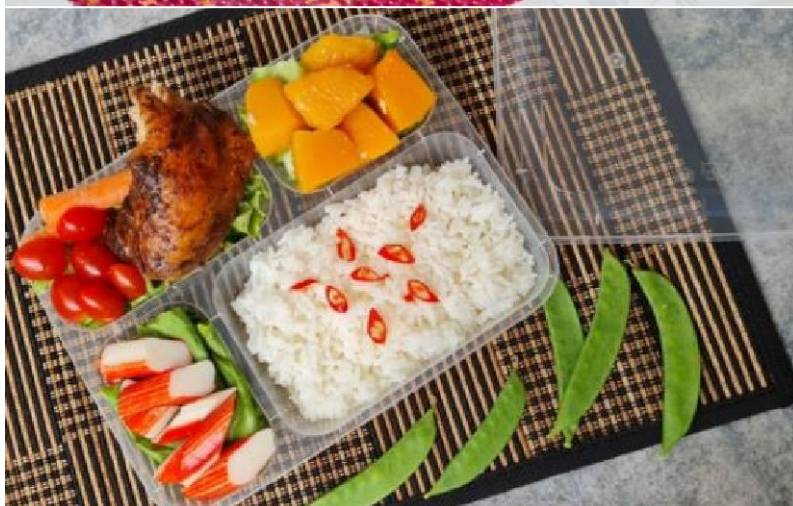

A-13-03(MS 1200QC)



SIZE : L227 x W177 x H45mm
PACKING : 50PCS /PKT
PACKING : 6PKT/ CTN



A-13-04(MS 1300TC)



SIZE : L254 x W121 x H60mm
PACKING : 50PCS /PKT
PACKING : 6PKT/ CTN

A-14-01(BX-121)



SIZE : L 193mm x W 193mm x H 70mm
PACKING : 300 PCS/CTN

A-14-02(BX-122)



SIZE : L 232mm x W 232mm x H 75mm
PACKING : 200 PCS/CTN

A-14-03(BTH-2)



SIZE : L 230mm x W 165mm x H 30mm
PACKING : 100 PCS/CTN

A-14-04(BTH-23)



SIZE : L 535mm x W 335mm x H 50mm
PACKING : 50 PCS/BAG

A-14-05(BX-PL09)(PP PLATE)



SIZE : D 230mm x 25mm
PACKING : 500 PCS/CTN
(10 X 50 PCS)

A-14-06(BX-PL10) (PP PLATE)



SIZE : D 253mm x 25mm
PACKING : 300 PCS/CTN
(10 X 30 PCS)

A-14-07(BX-PL07)(PP PLATE)



SIZE : D 175mm x W 25mm
PACKING : 1000 PCS/CTN
(20 X 50 PCS)

A-14-08(BX-04)(CHILI DISH)



SIZE : D 60mm x 15mm
PACKING : 15000PCS/CTN
(30 X 500 PCS)

A-14-09(SE-5)(4 SLICES SANDWICH WEDGES)



SIZE : L 167mm x W 90mm x H 70mm
PACKING : 1000PCS/BAG

A-15-01(BT-1-B)



SIZE : (LIDS) - L 235mm x W 185mm x H 20mm
(BASE) – L 230mm x W 175mm x H 35mm
PACKING : 600 PCS/CTN
(6 x 100 PCS)

A-15-02(BT-2-B)



SIZE : (LIDS) - L 235mm x W 185mm x H 20mm
(BASE) – L 230mm x W 175mm x H 35mm
PACKING : 600 PCS/CTN
(6 x 100 PCS)

A-15-03(BT-3-B)



SIZE : (LIDS) - L 235mm x W 185mm x H 20mm
(BASE) – L 230mm x W 175mm x H 35mm
PACKING : 600 PCS/CTN
(6 x 100 PCS)

A-15-04(BT-4)



SIZE : (LIDS) - L 235mm x W 185mm x H 20mm
(BASE) – L 230mm x W 175mm x H 35mm
PACKING : 600 PCS/CTN
(12 x 50 PCS) (RED/BLACK)

A-15-05(BTB-3CN-BLACK)



SIZE : (LIDS) - L 217mm x W 217mm x H 5mm
(BASE) – L 217mm x W 217mm x H 40mm
PACKING : 300 PCS/CTN
(3 x 100 PCS)

A-15-06(BTB-4C-BLACK)



SIZE : (LIDS) - L 230mm x W 220mm x H 5mm
(BASE) – L 230mm x W 220mm x H 35mm
PACKING : 300 PCS/CTN
(3 x 100 PCS)

A-15-07(BX-241)



SIZE : (LIDS) - L 215mm x W 180mm x H 20mm
(BASE) – L 228mm x W 192mm x H 38mm
PACKING : 600 PCS/CTN
(6 x 100 PCS)

A-15-08(BX-290)(LUNCH BOX (XXL) A-15-09(BX-170)(BURGER BOX)



SIZE : L 218mm x W 192mm x H 70mm
PACKING : 300 PCS/CTN
(6 X 50 PCS)



SIZE : L 128mm x W 128mm x H 55mm
PACKING : 1000PCS/CTN
(10 X 100 PCS)

A-16-01(BX-190)



SIZE : L 218mm x W 192mm x H 70mm
PACKING : 300 PCS/CTN
(6 X 50 PCS)

A-16-02(BX-210)



SIZE : L 262mm x W 165mm x H 80mm
PACKING : 200 PCS/CTN
(4 X 50 PCS)

A-16-03(BX-120) (Japanese hand rolled sushi box)



SIZE : L 170mm x W 90mm x H 45mm
PACKING : 600 PCS/CTN

A-16-04(FC-1)



SIZE : (LIDS) - L 275mm x W 220mm x H 10mm
(BASE) – L 265mm x W 210mm x H 40mm
PACKING : 400 PCS/CTN
(8 x 50 PCS)

A-16-05(FC-3)



SIZE : (LIDS) - L 275mm x W 220mm x H 10mm
(BASE) – L 265mm x W 210mm x H 40mm
PACKING : 400 PCS/CTN
(8 x 50 PCS)

A-16-06(FC-4)

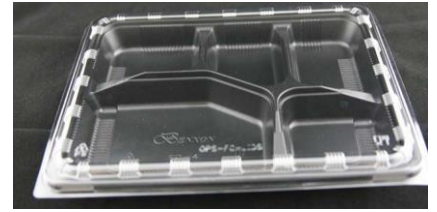

SIZE : (LIDS) - L 275mm x W 220mm x H 10mm
(BASE) – L 265mm x W 210mm x H 40mm
PACKING : 400 PCS/CTN
(8 x 50 PCS)

A-16-07(FC-5)

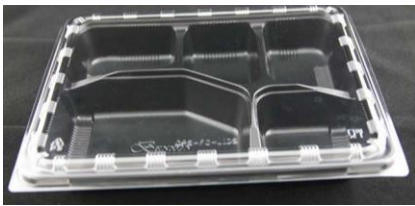

SIZE : (LIDS) - L 275mm x W 220mm x H 10mm
(BASE) – L 265mm x W 210mm x H 45mm
PACKING : 400 PCS/CTN
(8 x 50 PCS)

A-16-08(OPS-152L)



SIZE : L 130mm x W 92mm x H 60mm
PACKING : 1200PCS/CTN
(12 X 100 PCS)

A-16-09(OPS-153)



SIZE : L 190mm x W 95mm x H 60mm
PACKING : 1200PCS/CTN
(12 X 100 PCS)

A-17-01(OPS-H77L)
(SWISS ROLL CONTAINER)

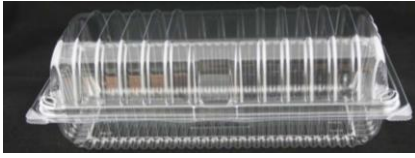

SIZE : L 245mm x W 120mm x H 70mm
PACKING : 1200PCS/CTN
(12 X 100 PCS)

A-17-02(OPS-L500)



SIZE : L 180mm x W 180mm x H 75mm
PACKING : 500PCS/CTN
(10 X 50 PCS)

A-17-03(OPS-C46)

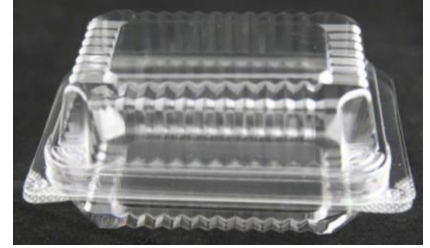

SIZE : L 140mm x W 105mm x H 60mm
PACKING : 600PCS/CTN
(12 X 50 PCS)

A-17-04(OPS-H100)



SIZE : L 75mm x W 50mm x H 30mm
PACKING : 7500PCS/CTN
(75 X 100 PCS)

A-17-05(OPS-H1)

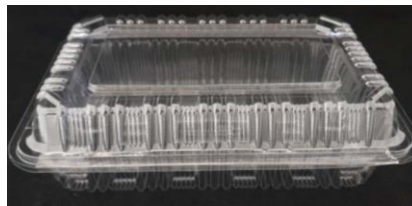

SIZE : L 190mm x W 130mm x H 50mm
PACKING : 2000PCS/CTN
(20 X 100 PCS)

A-17-06(OPS-H2)



SIZE : L 165mm x W 100mm x H 40mm
PACKING : 2000PCS/CTN
(20 X 100 PCS)

A-17-07(OPS-H3)



SIZE : L 120mm x W 100mm x H 30mm
PACKING : 5000PCS/CTN
(50 X 100 PCS)

A-17-08(OPS-H5)

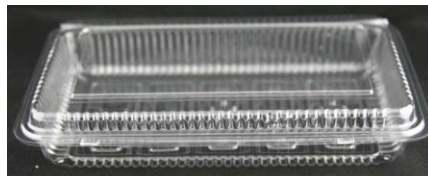

SIZE : L 240mm x W 145mm x H 40mm
PACKING : 2000PCS/CTN
(20 X 100 PCS)

A-17-09(OPS-H7)

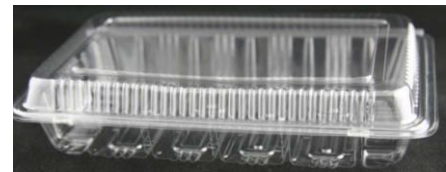

SIZE : L 215mm x W 135mm x H 45mm
PACKING : 2000PCS/CTN
(20 X 100 PCS)

A-18-01(OPS-H61)



SIZE : L 98mm x W 98mm x H
35mm
PACKING : 4800PCS/CTN
(48 X 100 PCS)

A-18-02(CH-2-B)



SIZE : L 172mm x W 106mm x H
30mm
Lid Height : 12mm
PACKING : 900PCS/CTN
(50 x 18 PCS)

A-18-03(EP2-ECO)



SIZE : L 178mm x W134mm x
H78mm
PACKING : 100PCS/PKT



STRAW



B-20-01 - SINGLE PC PACKING (OPP) – S. STRAW-SHARP END –
 SIZE : D 6mm x 203mm
 PACKING : (100PCS x 50PKT)/CTN



B-20-02- SINGLE PC PACKING (OPP)
 – GIANT STRAW(SHARP END) –
 SIZE : D 11mm x 210mm
 PACKING : (45PCS x 50PKT)/CTN



B-20-03 - BLACK STRAIGHT STRAW – SIZE : 8”
 PACKING : (250PCS x 40PKT)/CTN



B-20-04 - BLACK FLEXIBLE STRAW
 – SIZE : 8”
 PACKING : (250PCS x 40PKT)/CTN



B-20-05 - '99-SHORT' COLOUR STRAW – SIZE : 7.5”
 PACKING : 120PKT/BUNDLE



B-20-06 - '99-LONG' COLOUR STRAW – SIZE : 8.5”
 PACKING : 96PKT/BUNDLE



B-20-07 - SHORT GIANT STRAW – SIZE : D 12mm x 7”



B-20-08 - LONG GIANT STRAW –
 SIZE : D 12mm x L 9”



CUPS & LIDS

C-22-01(A-230)



MATERIAL TYPE : Polypropylene
SIZE : **Ø 80mm x H 79mm**
Capacity : **230 ml**
Lid Option : C-24-03, C-24-04,
C-24-05
PACKING : (100PCS x 10)/CTN

C-22-02(E-12S)



MATERIAL TYPE : Polypropylene
SIZE : **Ø 93.5mm x H 103.5mm**
Capacity : **360 ml**
Lid Option : C-24-06, C-24-07,
C-24-09, C-24-11
PACKING : (100PCS x 20)/CTN

C-22-03(E-16S)



MATERIAL TYPE : Polypropylene
SIZE : **Ø 93.5mm x H 118.4mm**
Capacity : **500 ml**
Lid Option : C-24-06 , C-24-07,
C-24-09, C-24-11
PACKING : (100PCS x 20)/CTN

C-22-04(E-22S)



MATERIAL TYPE : Polypropylene
SIZE : **Ø 93.5mm x H 150.8mm**
Capacity : **650 ml**
Lid Option : C-24-06, C-24-07,
C-24-09, C-24-11
PACKING : (50PCS x 20)/CTN

C-22-05(A-12)



MATERIAL TYPE : Polypropylene
SIZE : **Ø 93.5mm x H 103.5mm**
Capacity : **360 ml**
Lid Option : C-24-06, C-24-07,
C-24-09, C-24-11
PACKING : (100PCS x 20)/CTN

C-22-06(A-16)



MATERIAL TYPE : Polypropylene
SIZE : **Ø 93.5mm x H 117mm**
Capacity : **500 ml**
Lid Option : C-24-06, C-24-07,
C-24-09, C-24-11
PACKING : (100PCS x 20)/CTN

C-23-01
(A-22)



MATERIAL TYPE : Polypropylene
SIZE : \varnothing 93.5mm x H 150mm
Capacity : 650 ml
Lid Option : C-24-06, C-24-07,
C-24-09, C-24-11
PACKING : (50PCS x 20)/CTN

C-23-02
(E-32C)



MATERIAL TYPE : Polypropylene
SIZE : \varnothing 117mm x H 170mm
Capacity : 950 ml
Lid Option : C-24-12
PACKING : (50PCS x 20)/CTN

C-23-03(PC-12)



MATERIAL TYPE : A-PET
SIZE : \varnothing 92.7mm x H 106mm
Capacity : 360 ml
Lid Option : C-25-01, C-25-03,
C-25-04
PACKING : (50PCS x 20)/CTN

C-23-04(PC-16)



MATERIAL TYPE : A-PET
SIZE : \varnothing 98.6mm x H 119mm
Capacity : 500 ml
Lid Option : C-25-02, C-25-05,
C-25-06
PACKING : (50PCS x 20)/CTN

C-23-05(PC-20)



MATERIAL TYPE : A-PET
SIZE : \varnothing 98.6mm x H 136mm
Capacity : 600 ml
Lid Option : C-25-02, C-25-05,
C-25-06
PACKING : (50PCS x 20)/CTN



C-24-01(E-115T FL)
PACKING : (100PCS x 20)/CTN



C-24-02(DL-75)
PACKING : (100PCS x 20)/CTN



C-24-03(DL-80)
PACKING : (100PCS x 20)/CTN



C-24-04(E-360C FL Clear)
PACKING : (100PCS x 20)/CTN



C-24-05(E-360C FL Opaque)
PACKING : (100PCS x 20)/CTN



C-24-06(E-12/16/22 FL Clear)
PACKING : (100PCS x 20)/CTN



C-24-07(E-12/16/22 FL Opaque)
PACKING : (100PCS x 20)/CTN



C-24-08(E-16/22 PAC FL Opaque)
PACKING : (100PCS x 20)/CTN



C-24-09(DL-93)
PACKING : (100PCS x 20)/CTN



C-24-10(RDL-90)
PACKING : (100PCS x 20)/CTN



C-24-11(DL-W-95)
PACKING : (100PCS x 20)/CTN



C-24-12(DL-120)
PACKING : (100PCS x 20)/CTN



C-25-01(E-92 FL)
PACKING : (100PCS x 20)/CTN



C-25-02(E-98 FL)
PACKING : (100PCS x 20)/CTN



C-25-03(E-DL-92 "O" HOLE)
PACKING : (100PCS x 20)/CTN



C-25-04(E-DL-92 "X" CUT)
PACKING : (100PCS x 20)/CTN



C-25-05(E-DL-98 "O" HOLE)
PACKING : (100PCS x 20)/CTN



C-25-06(E-DL-98 "X" CUT)
PACKING : (100PCS x 20)/CTN



PET ROUND BOTTLE



- **C-25-07** – Capacity : 350ml
PACKING : 200PCS/BAG
- **C-25-08** – Capacity : 500ml
PACKING : 152PCS/BAG
- **C-25-09** – Capacity : 1500ml
PACKING : 60PCS/BAG



PAPER CUP



- **D-27-01 8 OZ PAPER CUP PLAIN WHITE – PACKING : 50 PCS X 40PKT**
- **D-27-02 9 OZ PAPER CUP PLAIN WHITE – PACKING : 50 PCS X 40PKT**
- **D-27-03 12 OZ COLD CUP PLAIN WHITE – PACKING : 100 PCS X 40PKT**
- **D-27-04 16 OZ COLD CUP PLAIN WHITE – PACKING : 50 PCS X 20PKT**
- **D-27-05 1 OZ PAPER SAMPLING CUP – PACKING : 50PCS X 100PKT**

PAPER HOT CUP



- **D-27-06 8 OZ
DOUBLE WALL
PLAIN WHITE –
PACKING : 25PCS X 40PKT**
- **D-27-07 12 OZ
DOUBLE WALL
PLAIN WHITE –
PACKING : 25PCS X 20PKT**



- **D-27-14 8 OZ RECLOSABLE
LID BLACK –
PACKING : 50PCS X 20PKT**
- **D-27-15 12 OZ
RECLOSABLE LID BLACK –
PACKING : 50PCS X 20PKT**

CUP SLEEVE



- **D-28-01 S SIZE CUP SLEEVE –**
PACKING : 100PCS X 20PKT
- **D-28-02 L SIZE CUP SLEEVE –**
PACKING : 100PCS X 20PKT



PULP PAPER CUPS HOLDER

2 Cup Holder



4 Cup Holder



- **D-28-03 PULP PAPER 2 CUPS**
HOLDER – PACKING : 600PCS/CTN
- **D-28-04 PULP PAPER 4 CUPS**
HOLDER – PACKING : 300PCS/CTN

NON-WOVEN PAPER CHEF CAP



- **D-28-05 PCH-9 – SIZE : 9”**
- **D-28-06 PCH-11 – SIZE : 11”**

PAPER BAG



TWISTED HANDLE PAPER BAG



- **D-29-01 (SOS #4 BROWN) – SIZE : 245mm x 127mm x 77mm
PACKING : (100PCS X 20PKT) / CTN**
- **D-29-02 (SOS #6 BROWN) – SIZE : 280mm x 147mm x 98mm
PACKING : (100PCS X 20PKT) / CTN**
- **D-29-03 (SOS #8 BROWN) – SIZE : 290mm x 154mm x 100mm
PACKING : (100PCS X 20PKT) / CTN**
- **D-29-04 (SOS #12 BROWN) – SIZE : 300mm x 178mm x 112mm
PACKING : (100PCS X 20PKT) / CTN**
- **D-29-05 (SOS #16 BROWN) – SIZE : 390mm x 240mm x 120mm
PACKING : 250PCS/ CTN**

- **D-29-06 (THP011) –
SIZE : 27cm x 21cm x 11cm
PACKING : 300PCS/CTN**
- **D-29-07 (THP014) –
SIZE : 27cm x 21cm x 14cm
PACKING : 300PCS/CTN**
- **D-29-08 (THP015) –
SIZE : 28cm x 28cm x 15cm
PACKING : 300PCS/CTN**
- **D-29-09 (THP018) –
SIZE : 30cm x 30cm x 18cm
PACKING : 300PCS/CTN**



D-BAG KRAFT PAPER

- **D-29-10 (DB01) – SIZE : 330mm x 220mm x 130mm
PACKING : 500PCS/CTN**
- **D-29-11 (DB02) – SIZE : 280mm x 280mm x 150mm
PACKING : 500PCS/CTN**

www.dmhygiene.com.my 018-6660642



PAPER BOWL SERIES



- **D-30-01 390CC PLAIN WHITE PAPER BOWL – PACKING : 50PCS X 20PKT**
- **D-30-02 390CC LID – PACKING : 50PCS X 20PKT**
- **D-30-03 520CC PLAIN WHITE PAPER BOWL – PACKING : 50PCS X 20PKT**
- **D-30-04 520CC LID – PACKING : 50PCS X 20PKT**
- **D-30-05 780CC PLAIN WHITE PAPER BOWL – PACKING : 50PCS X 20PKT**
- **D-30-06 780CC LID – PACKING : 50PCS X 20PKT**
- **D-30-07 850CC PLAIN WHITE PAPER BOWL – PACKING : 50PCS X 12PKT**
- **D-30-08 850CC PLAIN KRAFT BROWN PAPER BOWL – PACKING : 50PCS X 12PKT**
- **D-30-09 850CC PLAIN BLACK PAPER BOWL – PACKING : 50PCS X 12PKT**
- **D-30-10 1000CC PLAIN BROWN/WHITE PAPER BOWL – PACKING : 50PCS X 12PKT**
- **D-30-11 850CC/1000CC LID – PACKING : 50PCS X 12PKT**

PAPER PLATE



- **D-30-12 7" PLAIN WHITE PAPER PLATE – PACKING : (20PCS X 100PKT) /CTN**
- **D-30-13 9" PLAIN WHITE PAPER PLATE – PACKING : (20PCS X 75PKT) /CTN**



HAWKER PAPER



- **D-31-01 'APPLE-A' HAWKER PAPER – SIZE : 15.25" x 17.5"**
PACKING : (100PCS X 10PKT) /BUNDLE
- **D-31-02 'APPLE-B' HAWKER PAPER – SIZE : 14" x 16"**
PACKING : (100PCS X 10PKT) /BUNDLE
- **D-31-03 'APPLE-C' HAWKER PAPER – SIZE : 12" x 15.5"**
PACKING : (100PCS X 10PKT) /BUNDLE
- **D-31-04 'APPLE-D' HAWKER PAPER – SIZE : 11.5" x 12"**
PACKING : (100PCS X 10PKT) /BUNDLE

LUNCH BOX



S SIZE

M SIZE

L SIZE

- **E-31-01 LUNCH BOX S SIZE –**
SIZE : 120mm x 90mm x 45mm
Capacity : 600ML
- **E-31-02 LUNCH BOX M SIZE –**
SIZE : 150mm x 105mm x 46mm
Capacity : 750ML
- **E-31-03 LUNCH BOX L SIZE –**
SIZE : 180mm x 120mm x 50mm
Capacity : 1200ML



PIZZA BOX CORRUGATED BROWN



- **E-32-01 (PZ10) – SIZE : 10”
PACKING : 50PCS/PKT**
- **E-32-02 (PZ12) – SIZE : 12”
PACKING : 50PCS/PKT**



STRING ROLL



**E-32-03 (TIE-ST-1KG STRING ROLL-
THICK) – PACKING : 1 X 8 ROLL(1KG)**

DISPOSABLE SPOONS,
FORKS & KNIFE



BLACK PLASTIC SPOON, FORK & KNIFE



**F-34-01 6.5" DISPOSABLE
BLACK PLASTIC SPOON –
PACKING : 50PCS/PKT
(40PKT/CTN)**



**F-34-02 6.5" DISPOSABLE
BLACK PLASTIC FORK –
PACKING : 50PCS/PKT
(40PKT/CTN)**



**F-34-03 6.5" DISPOSABLE
BLACK PLASTIC KNIFE –
PACKING : 50PCS/PKT
(40PKT/CTN)**



**F-34-04 7" DISPOSABLE
BLACK PLASTIC SPOON –
PACKING : 50PCS/PKT
(40PKT/CTN)**



**F-34-05 7" DISPOSABLE
BLACK PLASTIC SPOON –
PACKING : 50PCS/PKT
(40PKT/CTN)**



**F-34-06 3 IN 1 6.5"
DISPOSABLE BLACK PLASTIC
SPOON, FORK & TISSUE –
PACKING : 50 SET/PKT
(10PKT/CTN)**

WHITE PLASTIC SPOON & FORK



**F-35-01 5" WHITE SPOON –
PACKING : 50PCS/PKT
(40PKT/CTN)**



**F-35-02 5" WHITE DESSERT FORK –
PACKING : 50PCS/PKT
(40PKT/CTN)**



**F-35-03 5" WHITE SPORK FORK –
PACKING : 50PCS/PKT
(40PKT/CTN)**



**F-35-04 6.5" DISPOSABLE
WHITE PLASTIC SPOON –
PACKING : 50PCS/PKT
(40PKT/CTN)**



**F-35-05 6.5" DISPOSABLE
WHITE PLASTIC FORK –
PACKING : 50PCS/PKT
(40PKT/CTN)**

CLEAR PLASTIC SPOON, FORK & KNIFE



- **F-36-01 'M.BUFF 165-CLEAR' PLASTIC SPOON – SIZE : 165mm
PACKING : 2000PCS/CTN (50PCS X 40PKT)**
- **F-36-02 'M.BUFF 165-CLEAR' PLASTIC FORK – SIZE : 165mm
PACKING : 2000PCS/CTN (50PCS X 40PKT)**



- **F-36-03 7½" LUXURY & THICK DISPOSABLE PLASTIC KNIFE – COLOUR : CLEAR
SIZE : 13.5 cm x 2.5 cm x 19.5 cm PACKING : (50PCS X 40PKT)/CTN**



- **F-36-04 7" TRANSPARENT DISPOSABLE PLASTIC SPOON –
PACKING : 50PCS/PKT (40PKT/CTN)**
- **F-36-05 7" TRANSPARENT DISPOSABLE PLASTIC FORK –
PACKING : 50PCS/PKT (40PKT/CTN)**



- **F-36-06 3.5" DISPOSABLE PLASTIC ICE CREAM MINI SPOON –
PACKING : 100PCS/PKT (20PKT/CTN)**



- **F-36-07 'M.BUFF TRANSPARENT SPOON – SIZE : 120mm
PACKING : 50PCS/PKT (60PKT/CTN)**

WOODEN SPOON, FORK & KNIFE



- **F-37-01** CRYSTALBIO BIODEGRADABLE WOODEN SPOON – SIZE : L 160mm
PACKING : 50PCS/PKT
- **F-37-02** DISPOSABLE BIODEGRADABLE WOODEN FORK – SIZE : L 160mm
PACKING : 100PCS/PKT
- **F-37-03** DISPOSABLE BIODEGRADABLE WOODEN KNIFE – SIZE : L 160mm
PACKING : 100PCS/PKT

CHINESE SPOON, CLEAR DISPOSABLE PP PLASTIC CHINESE SOUP SPOON, SHANGHAI SPOON & SOUP SPOON



F-37-04 CHINESE SPOON –
PACKING : 80PCS/PKT



F-37-05 CLEAR DISPOSABLE PP
PLASTIC CHINESE SOUP SPOON –
PACKING : 80PCS/PKT



F-37-06 SHANGHAI SPOON (WHITE) –
PACKING : 100PCS/PKT



F-37-07 SOUP SPOON (WHITE) –
PACKING : 100PCS/PKT

RUBBER BAND



G-38-01 RUBBER BAND - ORII GOLD –
SIZE (THICKNESS) : 1.0mm, 1.5mm
COLOUR : ORANGE-GOLD

TOOTHPICK



G-38-02 (TP500G) –
SIZE : L 20 cm x W 7 cm x H 6.5 cm
Capacity : 500 G

BAMBOO CHOPSTICK



G-38-03 (BC40) – SIZE : 4.5mm x 200mm
PACKING : 40 PAIRS X 100PKT /BUNDLE



BAMBOO SKEWER



- **G-39-01 (BS05)** –
SIZE : 5" x 2.5mm
PACKING : 300 gram X 90PKT /CTN
- **G-39-02 (BS06)** –
SIZE : 6" x 2.5mm
PACKING : 300 gram X 90PKT /CTN
- **G-39-03 (BS08)** –
SIZE : 8" x 2.5mm
PACKING : 500 gram X 55PKT /CTN
- **G-39-04 (BS10)** –
SIZE : 10" x 3mm
PACKING : 500 gram X 55PKT /CTN
- **G-39-05 (BS12)** –
SIZE : 12" x 3mm
PACKING : 500 gram X 55PKT /CTN

TEPPO SKEWER



- **G-39-06** – SIZE : 6" PACKING : 100PCS X 100PKT
- **G-39-07** – SIZE : 8" PACKING : 100PCS X 100PKT
- **G-39-08** – SIZE: 10" PACKING : 100PCS X 100PKT



FOOD WRAP FILM



- **H-40-01 (CWRAP 200) – SIZE : 200mm x 400mm
PACKING: 6 ROLLS/CTN**
- **H-40-02 (CWRAP 250) – SIZE : 250mm x 400mm
PACKING: 6 ROLLS/CTN**
- **H-40-03 (CWRAP 300) – SIZE : 300mm x 400mm
PACKING: 6 ROLLS/CTN**
- **H-40-04 (CWRAP 350) – SIZE : 350mm x 400mm
PACKING: 6 ROLLS/CTN**
- **H-40-05 (CWRAP 400) – SIZE : 400mm x 400mm
PACKING: 6 ROLLS/CTN**
- **H-40-06 (CWRAP 450) – SIZE : 450mm x 400mm
PACKING: 6 ROLLS/CTN**

CATERING FILM



**H-40-07 (CT300) – SIZE : 300mm x 300mm
PACKING: 12 ROLLS/CTN**



**H-40-08 (CT450) – SIZE : 450mm x 300mm
PACKING: 12 ROLLS/CTN**





ALLUMINIUM FOIL



H-41-01 AFOIL/300/7.62m –
 SIZE : 300mm x 7.62m (25 SQ.FT)
 PACKING : 24 ROLLS/CTN



H-41-02 AFOIL/450/7.62m –
 SIZE : 450mm x 7.62m (37.5 SQ.FT)
 PACKING : 24 ROLLS/CTN



H-41-03 AFOIL/450/1.15KG –
 SIZE : 450mm (1.15KG)
 PACKING : 6 ROLLS/CTN



BAKING PAPER



H-41-04 GP-BAKING PAPER/1
 CRYSTALWRAP NON-STICK
 BAKING PAPER SHEET –
 SIZE : 40cm x 60cm
 PACKING : 500 SHEETS/BOX



H-41-05 GP-BAKING PAPER/2
 CRYSTALWRAP NON-STICK
 BAKING PAPER ROLL 5m –
 SIZE : 30cm x 5m
 PACKING : 48 ROLLS/CTN

H-41-06 GP-BAKING PAPER/3
 CRYSTALWRAP NON-STICK
 BAKING PAPER 100m –
 SIZE : 450mm x 100m
 PACKING : 6 ROLLS/CTN



IVORY PAPER DOILY

- **H-42-01 (CK058) 4.5" IVORY PAPER DOILY – SIZE : 114mm PACKING:**
 - ❖ 200PCS (20PKT)/BOX
 - ❖ 12BOX/CTN
- **H-42-02 (CK059) 5.5" IVORY PAPER DOILY – SIZE : 140mm PACKING:**
 - ❖ 200PCS (20PKT)/BOX
 - ❖ 12BOX/CTN
- **H-42-03 (CK060) 6.5" IVORY PAPER DOILY – SIZE : 165mm PACKING:**
 - ❖ 200PCS (8PKT)/BOX
 - ❖ 12BOX/CTN
- **H-42-04 (CK061) 7.5" IVORY PAPER DOILY – SIZE : 190mm PACKING:**
 - ❖ 200PCS (8PKT)/BOX
 - ❖ 12BOX/CTN
- **H-42-05 (CK062) 8.5" IVORY PAPER DOILY – SIZE : 215mm PACKING:**
 - ❖ 200PCS (8PKT)/BOX
 - ❖ 12BOX/CTN
- **H-42-06 (CK063) 9.5" IVORY PAPER DOILY – SIZE : 240mm PACKING:**
 - ❖ 200PCS (8PKT)/BOX
 - ❖ 12BOX/CTN
- **H-42-07 (CK064) 10.5" IVORY PAPER DOILY – SIZE : 267mm PACKING:**
 - ❖ 200PCS (8PKT)/BOX
 - ❖ 12BOX/CTN

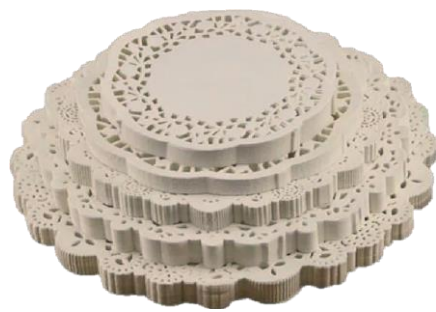



CHINESE STEAMER PAPER



- **H-43-01 (CK052) 4" STEAMER PAPER – SIZE : 10cm**
PACKING : -
 - ❖ 400PCS (20PKT)/BOX
 - ❖ 6BOX/CTN
- **H-43-02 (CK053) 4.5" STEAMER PAPER – SIZE : 12cm**
PACKING : -
 - ❖ 400PCS (20PKT)/BOX
 - ❖ 6BOX/CTN
- **H-43-03 (CK054) 5" STEAMER PAPER – SIZE : 13cm**
PACKING : -
 - ❖ 400PCS (20PKT)/BOX
 - ❖ 4BOX/CTN
- **H-43-04 (CK055) 5.5" STEAMER PAPER – SIZE : 14cm**
PACKING : -
 - ❖ 400PCS (20PKT)/BOX
 - ❖ 4BOX/CTN
- **H-43-05 (CK056) 6" STEAMER PAPER – SIZE : 15cm**
PACKING : -
 - ❖ 400PCS (10PKT)/BOX
 - ❖ 12BOX/CTN
- **H-43-06 (CK057) 7" STEAMER PAPER – SIZE : 18cm**
PACKING : -
 - ❖ 400PCS (4PKT)/BOX
 - ❖ 12BOX/CTN

ZIPLOCK BAG



Made of LDPE material with zipper design. It comes with various sizes, with a vast variety of packing and storage applications, e.g. accessories, electronic parts, medicine, grains, documents, bottles, gift packs, and many more!

- ±50 Micron for most sizes
- ±40 Micron for 40mm x 70mm, 2" x 3", 2.5" x 3" and 2.5" x 3.5"
- Cost-effective
- With zipper? ✓
- With stand? ✗

- **I-44-01** – SIZE : 40mm x 70mm
PACKING : 60,000PCS/BAG (100PCS X 600)
- **I-44-02** – SIZE : 2" x 3"
PACKING : 50,000PCS/BAG (100PCS X 500)
- **I-44-03** – SIZE : 2.5" X 3"
PACKING : 40,000PCS/BAG (100PCS X 400)
- **I-44-04** – SIZE : 2.5" X 3.5"
PACKING : 30,000PCS/BAG (100PCS X 300)
- **I-44-05** – SIZE : 3" X 4"
PACKING : 20,000PCS/BAG (100PCS X 200)
- **I-44-06** – SIZE : 3" X 5"
PACKING : 20,000PCS/BAG (100PCS X 200)
- **I-44-07** – SIZE : 3.5" X 5"
PACKING : 16,000PCS/BAG (100PCS X 160)
- **I-44-08** – SIZE : 4" X 6"
PACKING : 12,000PCS/BAG (100PCS X 120)
- **I-44-09** – SIZE : 5" X 8"
PACKING : 10,000PCS/BAG (100PCS X 100)
- **I-44-10** – SIZE : 6" X 9"
PACKING : 8,000PCS/BAG (100PCS X 80)
- **I-44-11** – SIZE : 7" X 10"
PACKING : 5,000PCS/BAG (100PCS X 50)
- **I-44-12** – SIZE : 8" X 12"
PACKING : 4,000PCS/BAG (100PCS X 40)
- **I-44-13** – SIZE : 9" X 14"
PACKING : 2,500PCS/BAG (100PCS X 25)
- **I-44-14** – SIZE : 10" X 16"
PACKING : 2,000PCS/BAG (100PCS X 20)
- **I-44-15** – SIZE : 12" X 18"
PACKING : 2,000PCS/BAG (100PCS X 20)
- **I-44-16** – SIZE : 13" X 18"
PACKING : 1,000PCS/BAG (100PCS X 10)



NYLON BAG/ VACUUM BAG



Suction Nozzle
Suitable for this vacuum sealer



Vacuum Groove
Not suitable for this vacuum sealer



- 3-side seal bag
- Both sides Nylon material
- ±80 Micron
- Vacuum sealed? ✓
- Kept in freezer? ✓
- Can be heated up to 100°C for 1 hour
- SGS Certification ✓

1PKT = 200PCS

- **I-45-01** 90mm x 120mm (3.5" x 4.7")
- **I-45-02** 100mm x 150mm (4" x 6")
- **I-45-03** 120mm x 170mm (5" x 7")
- **I-45-04** 145mm x 205mm (6" x 8")
- **I-45-05** 155mm x 230mm (6" x 9")

- **I-45-11** 230mm x 355mm (9" x 14")
- **I-45-12** 250mm x 300mm (10" x 12")
- **I-45-13** 260mm x 405mm (10" x 16")
- **I-45-14** 160mm x 290mm (6" x 11")

1PKT = 100PCS

- **I-45-15** 180mm x 500mm (7" x 20")
- **I-45-16** 200mm x 500mm (8" x 20")
- **I-45-17** 250mm x 900mm (10" x 35")
- **I-45-18** 300mm x 350mm (12" x 14")

NYLON EMBOSSED BAG



- 3-side seal bag
- Both sides Nylon material
- 1 side smooth surface 1 side emboss surface
- ±80 Micron
- Vacuum sealed? ✓
- Kept in freezer? ✓
- Can be heated up to 100oC for 1 hour
- Suitable for small vacuum machine only
- SGS Certification ✓

1PKT = 100PCS

- I-46-01 – SIZE : 80mm x 120mm (3" x 4.5")
- I-46-02 – SIZE : 90mm x 130mm (3.5" x 5")
- I-46-03 – SIZE : 100mm x 150mm (4" x 6")
- I-46-04 – SIZE : 120mm x 170mm (5" x 6.7")
- I-46-05 – SIZE : 120mm x 200mm (5" x 8")
- I-46-06 – SIZE : 130mm x 180mm (5" x 7")
- I-46-07 – SIZE : 145mm x 205mm (5.7" x 8")
- I-46-08 – SIZE : 150mm x 200mm (6" x 8")
- I-46-09 – SIZE : 150mm x 220mm (6" x 8.5")
- I-46-10 – SIZE : 155mm x 230mm (6" x 9")
- I-46-11 – SIZE : 160mm x 240mm (6" x 9.4")
- I-46-12 – SIZE : 180mm x 250mm (7" x 10")
- I-46-13 – SIZE : 180mm x 260mm (7" x 10.2")
- I-46-14 – SIZE : 200mm x 250mm (8" x 10")
- I-46-15 – SIZE : 200mm x 300mm (8" x 12")
- I-46-16 – SIZE : 220mm x 320mm (8.5" x 12.5")
- I-46-17 – SIZE : 230mm x 355mm (9" x 14")
- I-46-18 – SIZE : 250mm x 300mm (10" x 12")
- I-46-19 – SIZE : 250mm x 350mm (10" x 14")
- I-46-20 – SIZE : 260mm x 405mm (10" x 16")
- I-46-21 – SIZE : 280mm x 400mm (11" x 16")
- I-46-22 – SIZE : 300mm x 400mm (12" x 16")

LDPE PLASTIC BAG



- **I-47-01** – SIZE : 120mm x 170mm (4" x 6")
PACKING : 2KG/PKT (15PKT/BUNDLE)
- **I-47-02** – SIZE : 145mm x 205mm (5.5" x 8")
PACKING : 2KG/PKT (15PKT/BUNDLE)
- **I-47-03** – SIZE : 155mm x 230mm (6" x 9")
PACKING : 2KG/PKT (15PKT/BUNDLE)
- **I-47-04** – SIZE : 180mm x 250mm (7" x 10")
PACKING : 2KG/PKT (15PKT/BUNDLE)
- **I-47-05** – SIZE : 180mm x 500 mm (7" x 20")
PACKING : 2KG/PKT (15PKT/BUNDLE)
- **I-47-06** – SIZE : 200mm x 250mm (8" x 10")
PACKING : 2KG/PKT (15PKT/BUNDLE)
- **I-47-07** – SIZE : 200mm x 300mm (8" x 12")
PACKING : 2KG/PKT (15PKT/BUNDLE)
- **I-47-08** – SIZE : 200mm x 350mm (8" x 14")
PACKING : 2KG/PKT (15PKT/BUNDLE)
- **I-47-09** – SIZE : 230mm x 355mm (9" x 14")
PACKING : 2KG/PKT (15PKT/BUNDLE)
- **I-47-10** – SIZE : 250mm x 300mm (10" x 12")
PACKING : 2KG/PKT (15PKT/BUNDLE)
- **I-47-11** – SIZE : 260mm x 405mm (10" x 16")
PACKING : 2KG/PKT (15PKT/BUNDLE)
- **I-47-12** – SIZE : 300mm x 350mm (12" x 14")
PACKING : 2KG/PKT (15PKT/BUNDLE)
- **I-47-13** – SIZE : 305mm x 460mm (12" x 18")
PACKING : 2KG/PKT (15PKT/BUNDLE)



HM PLASTIC BAG



- I-48-01 – SIZE : 3" X 5"
- I-48-02 – SIZE : 4" X 6"
- I-48-03 – SIZE : 6" X 9" PACKING : 500GM
- I-48-04 – SIZE : 5" X 8" PACKING : 500GM
- I-48-05 – SIZE : 7" X 10" PACKING : 500GM
- I-48-06 – SIZE : 8" X 12" PACKING : 500GM
- I-48-07 – SIZE : 9" X 14" PACKING : 500GM
- I-48-08 – SIZE : 10" X 10" PACKING : 500GM
- I-48-09 – SIZE : 12" X 12" PACKING : 500GM
- I-48-10 – SIZE : 12" X 18" PACKING : 500GM
- I-48-11 – SIZE : 14" X 14" PACKING : 500GM
- I-48-12 – SIZE : 16" X 16" PACKING : 500GM
- I-48-13 – SIZE : 18" X 18" PACKING : 500GM
- I-48-14 – SIZE : 5" X 8" PACKING : 1KG
- I-48-15 – SIZE : 6" X 9" PACKING : 1KG
- I-48-16 – SIZE : 7" X 10" PACKING : 1KG
- I-48-17 – SIZE : 8" X 12" PACKING : 1KG
- I-48-18 – SIZE : 9" X 14" PACKING : 1KG
- I-48-19 – SIZE : 10" X 16" PACKING : 1KG
- I-48-20 – SIZE : 12" X 18" PACKING : 1KG
- I-48-21 – SIZE : 14" X 20" PACKING : 1KG
- I-48-22 – SIZE : 20" X 20" PACKING : 1KG
- I-48-23 – SIZE : 16" X 26" PACKING : 1KG
- I-48-24 – SIZE : 20" X 30" PACKING : 1KG
- I-48-25 – SIZE : 24" X 36" PACKING : 1.8KG
- I-48-26 – SIZE : 40" X 60" PACKING : 2KG





T-SHIRT BAG



- **I-50-01 JCP 10 ORANGE / WHITE – SIZE : 9 X 11 (70 PCS) PACKING : 350PKT/BUNDLE**
- **I-50-02 JCP 20 C.RED / WHITE – SIZE : 12 X 12 (50 PCS) PACKING : 300PKT/BUNDLE**
- **I-50-03 JCP 28 YELLOW / WHITE – SIZE : 12 X 16 (50 PCS) PACKING : 120PKT/BUNDLE**
- **I-50-04 JCP 30 R.RED/ WHITE – SIZE : 15 X 15 (50 PCS) PACKING : 180 PKT/BUNDLE**
- **I-50-05 JCP 38 C.RED/ WHITE – SIZE : 16 X 18 (50 PCS) PACKING : 80 PKT/BUNDLE**
- **I-50-06 JCP 40 ORANGE – SIZE : 17 X 19 (40 PCS) PACKING : 120 PKT/BUNDLE**
- **I-50-07 JCP 40W WHITE – SIZE : 17 X 19 (40 PCS) PACKING : 120 PKT/BUNDLE**
- **I-50-08 JCP 48 YELLOW/ WHITE – SIZE : 18 X 22 (40 PCS) PACKING : 80 PKT/BUNDLE**
- **I-50-09 JCP 55 C.RED/ WHITE – SIZE : 20 X 23 (40 PCS) PACKING : 80 PKT/BUNDLE**
- **I-50-10 JCP 65 YELLOW/ WHITE – SIZE : 22 X 24 (40 PCS) PACKING : 70 PKT/BUNDLE**
- **I-50-11 JCP 75 R.RED/ WHITE – SIZE : 24 X 28 (40 PCS) PACKING : 50 PKT/BUNDLE**
- **I-50-12 JCP 85 C.RED/ WHITE – SIZE : 26 X 33 (40 PCS) PACKING : 30 PKT/BUNDLE**

PE-T.SHIRT BAG



- **I-50-13 'BEE' PE-T.SHIRT BAG – SIZE : 10" X 13" PACKING : 500G**
- **I-50-14 'BEE' PE-T.SHIRT BAG – SIZE : 12" X 15" PACKING : 500G**
- **I-50-15 'BEE' PE-T.SHIRT BAG – SIZE : 13" X 16" PACKING : 500G**
- **I-50-16 'BEE' PE-T.SHIRT BAG – SIZE : 15" X 18" PACKING : 500G**
- **I-50-17 'BEE' PE-T.SHIRT BAG – SIZE : 18" X 20" PACKING : 500G**
- **I-50-18 'BEE' PE-T.SHIRT BAG – SIZE : 20" X 23" PACKING : 500G**

BAG ON ROLL



- **I-51-01**
5" X 8", 6" X 9", 7" X 10" BAG ON ROLL –
WEIGHT : 900 GM / ROLL
PACKING : 20 ROLL/BUNDLE
- **I-51-02**
8" X 12", 9" X 14", 10" X 16", 12" X 18", 14" X 20" BAG ON ROLL –
WEIGHT : 900GM/ROLL
PACKING : 20 ROLL/BUNDLE



GARBAGE BAG



- I-52-01 BLACK 32 x 40 (800G) – PACKING : 30 PKT/BUNDLE
- I-52-02 BLACK 35 x 40 (1 KG) – PACKING : 30 PKT/BUNDLE
- I-52-03 BLACK 35 x 40 (100PCS) – PACKING : 5 PKT/BUNDLE
- I-52-04 BLACK 36 x 48 (2 KG) – PACKING : 15PKT/BUNDLE
- I-52-05 BLUE 47 x 54 (30 PCS) – PACKING : 200PKT/BUNDLE
- I-52-06 BLACK 74 x 90 (10 PCS) – PACKING : 180PKT/BUNDLE
- I-52-07 YELLOW, BLUE, GREEN, WHITE 74 x 90 (10 PCS) – PACKING : 180PKT/BUNDLE
- I-52-08 BLACK 40 x 50 (2KG) – PACKING : 15PKT/BUNDLE
- I-52-09 BLACK 50 x 52 (10 PCS) – PACKING : 20PKT/BUNDLE



HYGIENE PRODUCTS LIST

CLEANING CHEMICAL



PACKING :
5L / 10L / 20L

OTHER

- WINDOW GLASS CLEANER
- HAND SOAP (LIQUID / FOAM)
- HAIR & BODY SHAMPOO
- CARPET CLEANER
- LAUNDRY FABRIC SOFTENER
- LAUNDRY POWDER

FLOOR CLEANING

- MULTI PURPOSE CLEANER
- AS DEODORIZER
- PINE GEL DISINFECTANT
- MOP & SHINE FLOOR CLEANER
- STAIN REMOVER
- BLEACH

KITCHEN CLEANING CHEMICAL

- GREASE TRAP ENZYME (10L)
- DISH WASH - LIQUID
- GREASE REMOVER (FLOOR)
- CUP STAIN REMOVER (POWDER)

TABLE CLEANING

- TABLE CLEAN (FLY REPELLENT)
- J-512 SURFACE SANITIZER (5L)

SANITIZER & DISINFECTANT

- FOOD GRADE DISINFECTANT – (5L)
- HAND SANITIZER ALCOHOL (5L)
- FOGGING DISINFECTANT (5L)
- NANO MIST DISINFECTANT (5L)

HYGIENE PRODUCTS LIST



SERVIETTE NAPKIN 45 PCS+- (PULP) WHITE TISSUES

- **J-54-01** - PACKING: 45 PCS X 60 PACK
SIZE: 220 MM X 280 MM

SERVIETTE NAPKIN [RECYCLE] WHITE/PINK TISSUES

- **J-54-02** – PACKING: 60 GM X 60PACK
SIZE: 235 MM X 300 MM



INTERFOLD HAND TOWEL (PULP)

- **J-54-03** - PACKING: 200'S X 20 PACK
SIZE: 190 MM X 205 MM

M-FOLD HAND TOWEL (PULP)

- **J-54-04** - PACKING: 250'S X 16 PACK
SIZE: 230 MM X 210MM



POP UP TISSUES (FULL WRAP)

- **J-54-08** 1PLY (HBT) PACKING: 250'S X 72 PACK
SIZE: 100MM X 200MM
- **J-54-10** 2PLY (HBT) PACKING: 150'S X 60 PACK
SIZE: 100MM X 200MM

J-54-07 POP UP TISSUES 1PLY (THICK) EMBROSS

PACKING : 200'S X 40 PACK
SIZE: 100MM X 200MM



- **J-55-01** V/P 1PLY COCKTAIL NAPKIN PLAIN/LOGO
 SIZE: **230MM X 240MM**
 PACKING: **200'S X 25PACK**
 PRICE: PLAIN 1 COLOR / 2 COLOR
- **J-55-02** V/P 2PLY COCKTAIL NAPKIN PLAIN/LOGO
 SIZE: **230MM X 240MM**
 PACKING: **100'S X 50PACK**
 PRICE: PLAIN 1 COLOR / 2 COLOR
- ❖ LOGO: MINIMUM ORDER 10 CARTON, BLOCK CHARGE: 1 COLOR



- **J-55-03** V/P 1PLY DINNER NAPKIN PLAIN/LOGO
 SIZE: **390MM X 400MM**
 PACKING: **200'S X 15PACK**
 PRICE: PLAIN 1 COLOR/ 2 COLOR
- **J-55-04** V/P 2PLY DINNER NAPKIN PLAIN/LOGO
 SIZE: **390MM X 400MM**
 PACKING: **100'S X 20PACK**
 PRICE: PLAIN 1 COLOR / 2 COLOR
- ❖ LOGO: MINIMUM ORDER 10 CARTON, BLOCK CHARGE: 1 COLOR



- **J-55-05** V/P 1PLY LAUNCHEON NAPKIN C-FOLD
 SIZE: **310MM X 320MM**
 PACKING: **200'S X 30PACK**
 PRICE: PLAIN 1 COLOR/ 2 COLOR
- **J-55-06** V/P 2PLY LAUNCHEON NAPKIN C-FOLD
 SIZE: **310MM X 320MM**
 PACKING: **100'S X 30PACK**
 PRICE: PLAIN 1 COLOR / 2 COLOR
- ❖ LOGO: MINIMUM ORDER 10 CARTON, BLOCK CHARGE: 1 COLOR



PAPER STRAW 6MM / 8MM / 12MM X 210MM WRAPPED AND NOT WRAP

- **J-55-07** – SIZE : **6MM**
 PACKING : **100PCS X 100PACK**
- **J-55-08** – SIZE : **8MM**
 PACKING : **100PCS X 60PACK**
- **J-55-09** – SIZE : **12MM**
 PACKING : **100PCS X 30PACK**



- **J-56-01 JUMBO ROLL (PULP) TISSUE 130 Meter**
PACKING: 130 Meter X 12ROLLS
- **J-56-02 JUMBO ROLL (PULP) TISSUE 260 Meter**
PACKING: 260 Meter X 12ROLLS
- **J-56-03 JUMBO ROLL (RECYCLE) TISSUE 600GM**
PACKING: 600GM X 12ROLLS



WET TISSUE PEARLY WIPES

PACKING:

- **J-56-03 S SIZE - 100PCS X 10PACKS**
- **J-56-04 L SIZE - 100PCS X 10PACKS**

LOGO PRINTING

AVAILABLE



HAND SANITIZER WIPES 75% & NON-ALCOHOL SANITIZING WIPES

- **75% ALCOHOL WIPES**
 - **J-56-05 30PACKS X 12BOX**
 - **J-56-06 50PCS X 10PACKS**
- **NON-ALCOHOL WIPES**
 - **J-56-07 30PACKS X 12BOX**
 - **J-56-08 50PCS X 10PACKS**

SMALL TOILET ROLL



J-56-09 SMALL TOILET ROLL (RECYCLE) –
PACKING : 10PKT (100 ROLL)/BUNDLE

THERMAL PAPER ROLL

www.dmhygiene.com.my 018-6660642



J-57-01 THERMAL PAPER ROLL –
SIZE : 80mm x 60mm
PACKING : 10ROLLS/PKT (10PKT/CTN)



J-57-02 CREDIT CARD MACHINE
THERMAL PAPER ROLL –
SIZE : 57mm x 44mm
PACKING : 10ROLLS/PKT (20PKT/CTN)



DISPOSABLE HAND GLOVES

www.dmhygiene.com.my 018-6660642



**J-58-01 NITRILE GLOVE BLUE – SIZE : S , M , L
PACKING : 100PCS X 10 BOX**



**J-58-02 VINYL GLOVE BLUE – SIZE : M , L
PACKING : 100PCS X 10 BOX**



**J-58-03 CPE PLASTIC GLOVE – SIZE : M , L
PACKING : 100PCS X 50 BOX**



**J-58-04 HDPE PLASTIC GLOVE (FREE SIZES)
PACKING : 100PCS X 50 BOX**



PPE (PERSONAL PROTECTIVE EQUIPMENT)



**J-59-01 BOUFFANT CAP – SIZE : 18” , 12”
COLOUR : White**



J-59-02 SHOE COVER - Free Size



**J-59-03 FACE MASK – TYPES : Transparent
MATERIAL : Plastic**



**J-59-04 FACE MASK – TYPES : 1Ply
MATERIAL : Paper**



**J-59-07 PREMIUM
DISPOSABLE PE APRON–
SIZE : 80cm x 130cm
COLOUR : White**



**J-59-05 FACE MASK –
TYPES : 2 Ply
MATERIAL : Non-woven**



**J-59-06 APRON - CPE–
SIZE : 62cm x 100cm
COLOUR : Yellow**



KITCHENWARE



ACRYLIC

K-61-01(JD-3807)



**ACRYLIC CONDIMENT SET
PLATE**
SIZE: L27cm x W10.7cm x H
1.5 cm

K-61-02(JD-1801A)



**ACRYLIC CONDIMENT
BOTTLE**
SIZE: D 7 cm x H 8 cm

K-61-03(JD-1802A)



ACRYLIC OIL POT (SMALL)
SIZE: D 5 cm x H 10 cm

K-61-04(JD-1803A)



ACRYLIC OIL POT (MEDIUM)
SIZE: D 5.5 cm x H 11.5 cm

K-61-05(JD-1804A)



ACRYLIC OIL POT (LARGE)
SIZE: D 6 cm x H 13.5 cm

K-61-06(JD-1805A)



**ACRYLIC OIL POT (EXTRA
LARGE)**
SIZE: D 6.5 cm x H 15.5 cm

K-61-07(JD-1806A)



**ACRYLIC TOOTHPICK
BOTTLE**
SIZE: D 5 cm x H 10 cm

K-61-08(JD-1811)



**ACRYLIC TOOTHPICK
HOLDER**
SIZE: D 5.4 cm x H 8 cm

K-61-09(JD-1812)



**ACRYLIC SUGAR PACKET
HOLDER**
SIZE: L 9 cm x W 6 cm x H 5.5
cm

K-62-01(JD-1813)



ACRYLIC DIAMOND PEPPER SHAKER

SIZE: D 4 cm x H 9 cm

K-62-02(JD-1816)



SQUARE ACRYLIC TOOTHPICK HOLDER

SIZE: L 5 cm x W 5 cm x H 7.5 cm

K-62-03(JD-8308)



ACRYLIC WOODEN CAP PEPPER MILL

SIZE: D 6 cm x H 18 cm

K-62-04(JD-8801)



ACRYLIC CERAMIC STYLE OIL

SIZE: D 7.5 cm x H 11.5 cm

K-62-05(JD-8802)



ACRYLIC SUGAR BOWL WITH COVER

SIZE: D 8 cm x H 9.7 cm

K-62-06(JD-8803)



ACRYLIC CONDIMENT JAR

SIZE: D 9 cm x H 9.5 cm

K-62-07(JD-8804)



ACRYLIC CONDIMENT JAR

SIZE: D 9 cm x H 9.5 cm

K-62-08(JD-8805)



ACRYLIC OIL CONTAINER – BIG

SIZE: D 14.5 cm x H 10.5 cm

K-62-09(JD-8806)



ACRYLIC OIL CONTAINER - SMALL

SIZE: D 8 cm x H 9.7 cm



GASTRONORM PAN (GN PAN)

PAN LAYOUTS

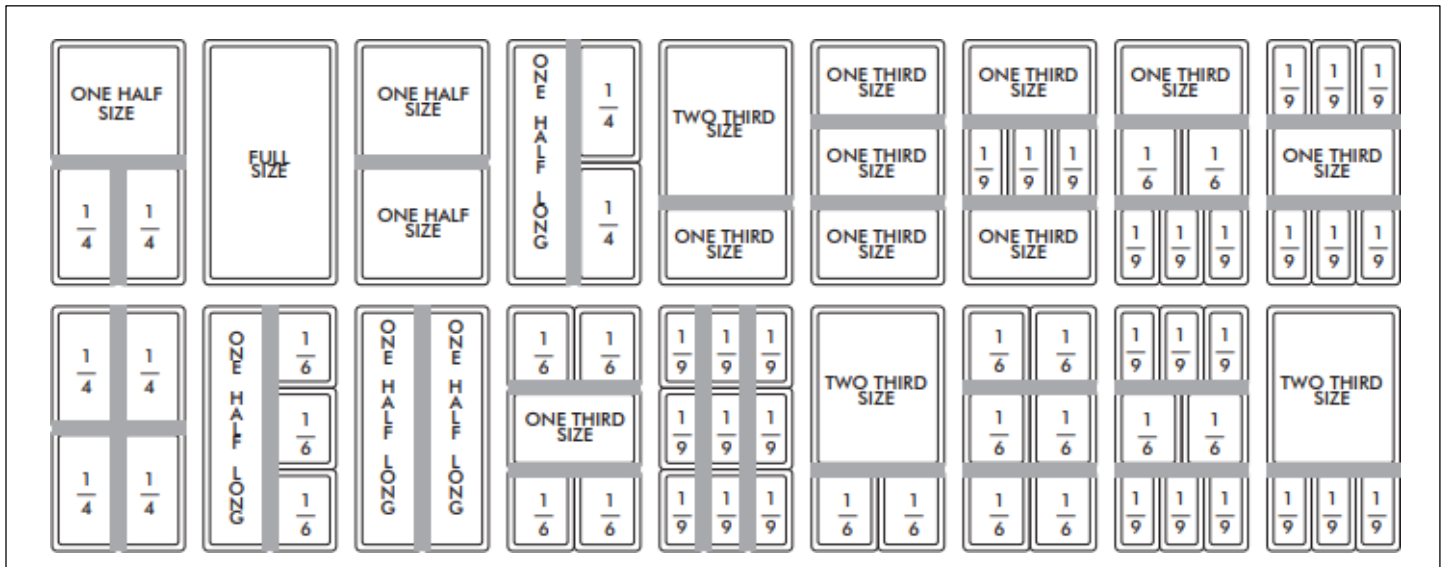

2/1 S/STEEL GN PAN



- **L-65-01 821-20T – SIZE : (2/1 x 20(1")) 650mm x 530mm x 20mm
THICKNESS : 0.6mm PACKING : 6PCS/CTN**
- **L-65-02 821-40T – SIZE : (2/1 x 40(1 1/2")) 650mm x 530mm x 40mm
THICKNESS : 0.6mm PACKING : 6PCS/CTN**
- **L-65-03 821-2CT – SIZE : (2/1 x 65(2 1/2")) 650mm x 530mm x 65mm
THICKNESS : 0.6mm PACKING : 6PCS/CTN**
- **L-65-04 821-4CT – SIZE : (2/1 x 100(4")) 650mm x 350mm x 100mm
THICKNESS : 0.6mm PACKING : 6PCS/CTN**



L-65-05 821-LT GN PAN COVER



L-65-06 821-CTSP GN PAN 3MM PERFORATED

1/1 S/STEEL GN PAN



- **L-66-01 811-25T –**
SIZE : (1/1 x 25(1")) 530mm x 325mm x 25mm
THICKNESS : 0.6mm PACKING : 6PCS/CTN
- **L-66-02 811-40T –**
SIZE : (1/1 x 40(1 1/2")) 530mm x 325mm x 40mm
THICKNESS : 0.6mm PACKING : 6PCS/CTN
- **L-66-03 811-2CT –**
SIZE : (1/1 x 65(2 1/2")) 530mm x 325mm x 65mm
THICKNESS : 0.6mm PACKING : 6PCS/CTN
- **L-66-04 811-4CT –**
SIZE : (1/1 x 100(4")) 530mm x 325mm x 100mm
THICKNESS : 0.6mm PACKING : 6PCS/CTN
- **L-66-05 811-6CT –**
SIZE : (1/1 x 150(6")) 530mm x 325mm x 150mm
THICKNESS : 0.6mm PACKING : 6PCS/CTN
- **L-66-06 811-8CT –**
SIZE : (1/1 x 200(8")) 530mm x 325mm x 200mm
THICKNESS : 0.6mm PACKING : 6PCS/CTN

1/2 S/STEEL GN PAN



- **L-66-07 812-25T–** SIZE : (1/2 x 25(1")) 325mm x 265mm x 25mm THICKNESS : 0.6mm
PACKING : 12PCS/CTN
- **L-66-08 812-40T–** SIZE : (1/2 x 40(1 1/2")) 325mm x 265mm x 40mm THICKNESS : 0.6mm
PACKING : 12PCS/CTN
- **L-66-09 812-2CT–** SIZE : (1/2 x 65(2 1/2")) 325mm x 265mm x 65mm THICKNESS : 0.6mm
PACKING : 12PCS/CTN
- **L-66-10 812-4CT–** SIZE : (1/2 x 100(4")) 325mm x 265mm x 100mm THICKNESS : 0.6mm
PACKING : 12PCS/CTN
- **L-66-11 812-6CT–** SIZE : (1/2 x 150(6")) 325mm x 265mm x 150mm THICKNESS : 0.6mm
PACKING : 12PCS/CTN
- **L-66-12 812-8CT–** SIZE : (1/2 x 200(8")) 325mm x 265mm x 200mm THICKNESS : 0.6mm
PACKING : 12PCS/CTN

1/3 S/STEEL GN PAN



- **L-67-01** 813-2CT-
SIZE : (1/3 x 65(2 1/2")) 325mm x 176mm x 65mm
THICKNESS : 0.6mm PACKING : 12PCS/CTN
- **L-67-02** 813-4CT-
SIZE : (1/3 x 100(4")) 325mm x 176mm x 100mm
THICKNESS : 0.6mm PACKING : 12PCS/CTN
- **L-67-03** 813-6CT-
SIZE : (1/3 x 150(6")) 325mm x 176mm x 150mm
THICKNESS : 0.6mm PACKING : 12PCS/CTN
- **L-67-04** 813-8CT-
SIZE : (1/3 x 200(8")) 325mm x 176mm x 200mm
THICKNESS : 0.6mm PACKING : 12PCS/CTN

1/4 S/STEEL GN PAN



- **L-67-05** 814-20 -
SIZE : (1/4 x 20(1")) 260mm x 162mm x 20mm
THICKNESS : 0.6mm PACKING : 24PCS/CTN
- **L-67-06** 814-2CT-
SIZE : (1/4 x 65(2 1/2")) 260mm x 162mm x 65mm
THICKNESS : 0.6mm PACKING : 24PCS/CTN
- **L-67-07** 814-4CT-
SIZE : (1/4 x 100(4")) 260mm x 162mm x 100mm
THICKNESS : 0.6mm PACKING : 24PCS/CTN
- **L-67-08** 814-6CT-
SIZE : (1/4 x 150(6")) 260mm x 162mm x 150mm
THICKNESS : 0.6mm PACKING : 24PCS/CTN
- **L-67-09** 814-8CT-
SIZE : (1/4 x 200(8")) 260mm x 162mm x 200mm
THICKNESS : 0.6mm PACKING : 24PCS/CTN

1/6 S/STEEL GN PAN



- **L-67-10** 816-2CT-
SIZE : (1/6 x 65(2 1/2")) 176mm x 162mm x 65mm
THICKNESS : 0.6mm PACKING : 36PCS/CTN
- **L-67-11** 816-4CT-
SIZE : (1/6 x 100(4")) 176mm x 162mm x 100mm
THICKNESS : 0.6mm PACKING : 36PCS/CTN
- **L-67-12** 816-6CT-
SIZE : (1/6 x 150(6")) 176mm x 162mm x 150mm
THICKNESS : 0.6mm PACKING : 36PCS/CTN
- **L-67-13** 816-8CT-
SIZE : (1/6 x 200(8")) 176mm x 162mm x 200mm
THICKNESS : 0.6mm PACKING : 36PCS/CTN

1/9 S/STEEL GN PAN



- **L-68-01** 819-2CT –
SIZE : (1/9 x 65(2 1/2")) 176mm x 108mm x 65mm
THICKNESS : 0.6mm PACKING : 48PCS/CTN
- **L-68-02** 819-4CT –
SIZE : (1/9 x 100(4")) 176mm x 108mm x 100mm
THICKNESS : 0.6mm PACKING : 48PCS/CTN
- **L-68-03** 819-6CT –
SIZE : (1/9 x 150(6")) 176mm x 108mm x 150mm
THICKNESS : 0.6mm PACKING : 48PCS/CTN

2/3 S/STEEL GN PAN



- **L-68-04** 823-25T–
SIZE : (2/3 x 25(1")) 353mm x 325mm x 25mm
THICKNESS : 0.6mm PACKING : 12PCS/CTN
- **L-68-05** 823-2CT–
SIZE : (2/3 x 65(2 1/2")) 353mm x 325mm x 65mm
THICKNESS : 0.6mm PACKING : 12PCS/CTN
- **L-68-06** 823-4CT–
SIZE : (2/3 x 100(4")) 353mm x 325mm x 100mm
THICKNESS : 0.6mm PACKING : 12PCS/CTN
- **L-68-07** 823-6CT–
SIZE : (2/3 x 150(6")) 353mm x 325mm x 150mm
THICKNESS : 0.6mm PACKING : 12PCS/CTN
- **L-68-08** 823-8CT–
SIZE : (2/3 x 200(8")) 353mm x 325mm x 200mm
THICKNESS : 0.6mm PACKING : 12PCS/CTN

1/1 S/STEEL DIVIDED GN PAN



- **L-68-09** 811-2Tx2 –
SIZE : (1/1x 65(2 1/2"))530mm x 325mm x 65mm
PACKING : 6PCS/CTN

GN PAN COVER



- L-69-01 811-LT– SIZE : GN 1/1 (530mm x 325mm) PACKING : 6PCS/CTN
- L-69-02 812-LT– SIZE : GN 1/2 (325mm x 265mm) PACKING : 12PCS/CTN
- L-69-03 813-LT– SIZE : GN 1/3 (325mm x 176mm) PACKING : 18PCS/CTN
- L-69-04 814-LT– SIZE : GN 1/4 (265mm x 162mm) PACKING : 24PCS/CTN
- L-69-05 816-LT– SIZE : GN 1/6 (176mm x 162mm) PACKING : 36PCS/CTN
- L-69-06 819-LT– SIZE : GN 1/9 (176mm x 108mm) PACKING : 48PCS/CTN
- L-69-07 823-LT– SIZE : GN 2/3 (352mm x 325mm) PACKING : 12PCS/CTN
- L-69-08 821-LT– SIZE : GN 2/1 (530mm x 650mm) PACKING : 6PCS/CTN

GN PAN COVER WITH NOTCH



- L-69-09 811-LTN – SIZE : GN 1/1 (530mm x 325mm) PACKING : 6PCS/CTN
- L-69-10 812-LTN – SIZE : GN 1/2 (325mm x 265mm) PACKING : 12PCS/CTN
- L-69-11 813-LTN – SIZE : GN 1/3 (325mm x 176mm) PACKING : 18PCS/CTN
- L-69-12 814-LTN – SIZE : GN 1/4 (265mm x 162mm) PACKING : 24PCS/CTN
- L-69-13 816-LTN – SIZE : GN 1/6 (176mm x 162mm) PACKING : 36PCS/CTN
- L-69-14 819-LTN – SIZE : GN 1/9 (176mm x 108mm) PACKING : 48PCS/CTN
- L-69-15 823-LTN – SIZE : GN 2/3 (352mm x 325mm) PACKING : 12PCS/CTN
- L-69-16 821-LTN – SIZE : GN 2/1 (530mm x 650mm) PACKING : 6PCS/CTN

PERFORATED GN PAN

1/1 S/STEEL PERFORATED GN PAN



- **L-70-01 811-25CTSP –**
SIZE : (1/1 x 25(1")) 530mm x 325mm x 25mm
THICKNESS : 0.6mm PACKING : 6PCS/CTN
- **L-70-02 811-40 CTSP –**
SIZE : (1/1 x 40(1 1/2")) 530mm x 325mm x 40mm
THICKNESS : 0.6mm PACKING : 6PCS/CTN
- **L-70-03 811-2CTSP –**
SIZE : (1/1 x 65(2 1/2")) 530mm x 325mm x 65mm
THICKNESS : 0.6mm PACKING : 6PCS/CTN
- **L-70-04 811-4CTSP –**
SIZE : (1/1 x 100(4")) 530mm x 325mm x 100mm
THICKNESS : 0.6mm PACKING : 6PCS/CTN
- **L-70-05 811-6CTSP –**
SIZE : (1/1 x 150(6")) 530mm x 325mm x 150mm
THICKNESS : 0.6mm PACKING : 6PCS/CTN

1/2 S/STEEL PERFORATED GN PAN



- **L-70-06 812-25CTSP –** SIZE : (1/2 x 25(1")) 325mm x 265mm x 25mm THICKNESS : 0.6mm
PACKING : 12PCS/CTN
- **L-70-07 812-40CTSP –** SIZE : (1/2 x 40(1 1/2")) 325mm x 265mm x 40mm THICKNESS : 0.6mm
PACKING : 12PCS/CTN
- **L-70-08 812-2CTSP –** SIZE : (1/2 x 65(2 1/2")) 325mm x 265mm x 65mm THICKNESS : 0.6mm
PACKING : 12PCS/CTN
- **L-70-09 812-4CTSP –** SIZE : (1/2 x 100(4")) 325mm x 265mm x 100mm THICKNESS : 0.6mm
PACKING : 12PCS/CTN
- **L-70-10 812-6CTSP –** SIZE : (1/2 x 150(6")) 325mm x 265mm x 150mm THICKNESS : 0.6mm
PACKING : 12PCS/CTN

2/3 S/STEEL PERFORATED GN PAN



- **L-71-01 823-2CTSP –**
SIZE : (2/3 x 65(2 1/2")) 353mm x 325mm x 65mm
THICKNESS : 0.6mm PACKING : 12PCS/CTN
- **L-71-02 823-4CTSP –**
SIZE : (2/3 x 100(4")) 353mm x 325mm x 100mm
THICKNESS : 0.6mm PACKING : 12PCS/CTN

2/1 S/STEEL PERFORATED GN PAN



- **L-71-03 821-20CTSP –**
SIZE : (2/1 x 20(1")) 650mm x 530mm x 20mm
THICKNESS : 0.6mm PACKING : 6PCS/CTN
- **L-71-04 821-2CTSP –**
SIZE : (2/1 x 65(2 1/2")) 650mm x 530mm x 65mm
THICKNESS : 0.6mm PACKING : 6PCS/CTN
- **L-71-05 821-4CTSP –**
SIZE : (2/1 x 100(4")) 650mm x 350mm x 100mm
THICKNESS : 0.6mm PACKING : 6PCS/CTN

POLYCARBONATE GN PAN

1/1 PC GN PAN



- **L-72-01** JD-P1106 –
SIZE : (1/1 x 65(2 1/2")) 530mm x 325mm x 65mm THICKNESS : 0.6mm PACKING : 6PCS/CTN
- **L-72-02** JD-P1110 –
SIZE : (1/1 x 100(4")) 530mm x 325mm x 100mm THICKNESS : 0.6mm PACKING : 6PCS/CTN
- **L-72-03** JD-P1115 –
SIZE : (1/1 x 150(6")) 530mm x 325mm x 150mm THICKNESS : 0.6mm PACKING : 6PCS/CTN
- **L-72-04** JD-P1120 –
SIZE : (1/1 x 200(8")) 530mm x 325mm x 200mm THICKNESS : 0.6mm PACKING : 6PCS/CTN

1/2 PC GN PAN



- **L-72-05** JD-P1206 –
SIZE : (1/2 x 65(2 1/2")) 325mm x 265mm x 65mm THICKNESS : 0.6mm PACKING : 12PCS/CTN
- **L-72-06** JD-P1210 –
SIZE : (1/2 x 100(4")) 325mm x 265mm x 100mm THICKNESS : 0.6mm PACKING : 12PCS/CTN
- **L-72-07** JD-P1215 –
SIZE : (1/2 x 150(6")) 325mm x 265mm x 150mm THICKNESS : 0.6mm PACKING : 12PCS/CTN
- **L-72-08** JD-P1220 –
SIZE : (1/2 x 200(8")) 325mm x 265mm x 200mm THICKNESS : 0.6mm PACKING : 12PCS/CTN

1/3 PC GN PAN



- **L-73-01** JD-P1306 –
SIZE : (1/3 x 65(2 1/2")) 325mm x 176mm x 65mm THICKNESS : 0.6mm PACKING : 12PCS/CTN
- **L-73-02** JD-P1310 –
SIZE : (1/3 x 100(4")) 325mm x 176mm x 100mm THICKNESS : 0.6mm PACKING : 12PCS/CTN
- **L-73-03** JD-P1315 –
SIZE : (1/3 x 150(6")) 325mm x 176mm x 150mm THICKNESS : 0.6mm PACKING : 12PCS/CTN
- **L-73-04** JD-P1320 –
SIZE : (1/3 x 200(8")) 325mm x 176mm x 200mm THICKNESS : 0.6mm PACKING : 12PCS/CTN

1/4 PC GN PAN

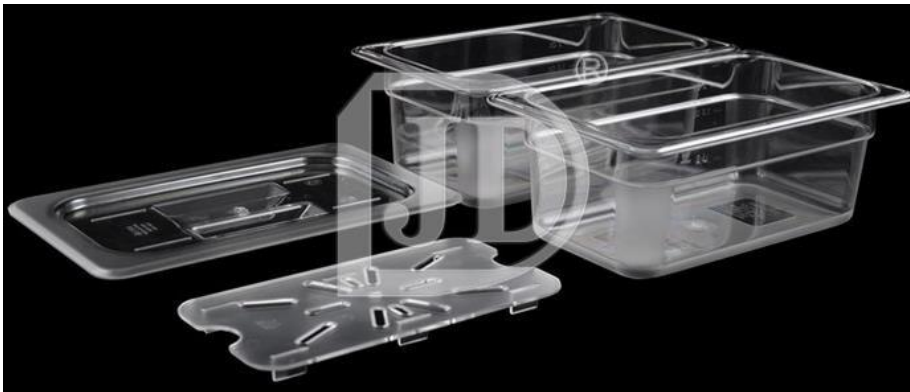

- **L-73-05** JD-P1406 –
SIZE : (1/4 x 65(2 1/2")) 265mm x 162mm x 65mm THICKNESS : 0.6mm PACKING : 24PCS/CTN
- **L-73-06** JD-P1410 –
SIZE : (1/4 x 100(4")) 265mm x 162mm x 100mm THICKNESS : 0.6mm PACKING : 24PCS/CTN
- **L-73-07** JD-P1415 –
SIZE : (1/4 x 150(6")) 265mm x 162mm x 150mm THICKNESS : 0.6mm PACKING : 24PCS/CTN

1/6 PC GN PAN



- **L-74-01 JD-P1606 –**
SIZE : (1/6 x 65(2 1/2")) 176mm x 162mm x 65mm THICKNESS : 0.6mm PACKING : 36PCS/CTN
- **L-74-02 JD-P1610 –**
SIZE : (1/6 x 100(4")) 176mm x 162mm x 100mm THICKNESS : 0.6mm PACKING : 36PCS/CTN
- **L-74-03 JD-P1615 –**
SIZE : (1/6 x 150(6")) 176mm x 162mm x 150mm THICKNESS : 0.6mm PACKING : 36PCS/CTN

1/9 PC GN PAN

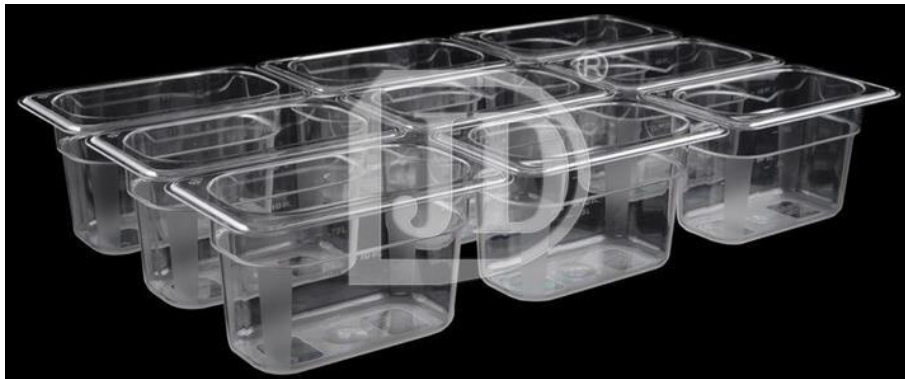

- **L-74-04 JD-P1906 –**
SIZE : (1/9 x 65(2 1/2")) 176mm x 108mm x 65mm THICKNESS : 0.6mm PACKING : 48PCS/CTN
- **L-74-05 JD-P1910 –**
SIZE : (1/9 x 100(4")) 176mm x 108mm x 100mm THICKNESS : 0.6mm PACKING : 48PCS/CTN

PC GN PAN COVER

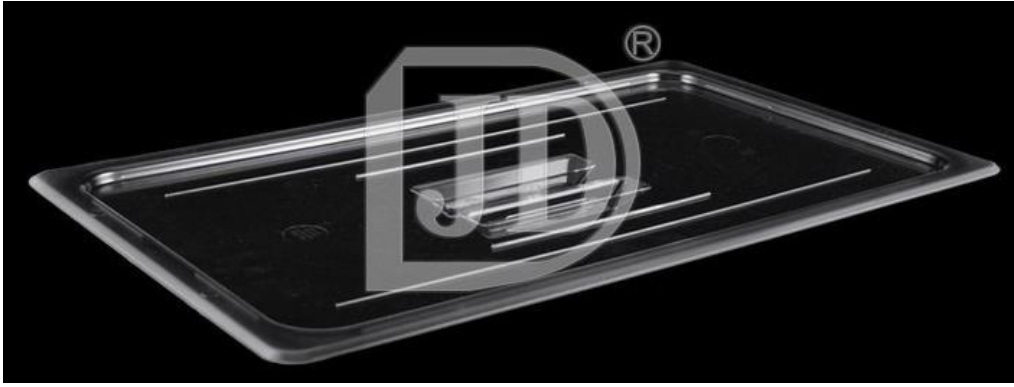

- **L-75-01** JD-P1101 1/1 – SIZE : **530mm x 325mm** PACKING : **6PCS/CTN**
- **L-75-02** JD-P1201 1/2 – SIZE : **325mm x 265mm** PACKING : **12PCS/CTN**
- **L-75-03** JD-P1301 1/3 – SIZE : **325mm x 176mm** PACKING : **18PCS/CTN**
- **L-75-04** JD-P1401 1/4 – SIZE : **265mm x 162mm** PACKING : **24PCS/CTN**
- **L-75-05** JD-P1601 1/6 – SIZE : **176mm x 162mm** PACKING : **36PCS/CTN**
- **L-75-06** JD-P1901 1/9 – SIZE : **176mm x 108mm** PACKING : **48PCS/CTN**

PC GN PAN DRAINER PLATE



- **L-75-07** JD-P1102 1/1 – SIZE : **460mm x 250mm x 15mm** PACKING : **6PCS/CTN**
- **L-75-08** JD-P1202 1/2 – SIZE : **251mm x 196mm x 15mm** PACKING : **12PCS/CTN**
- **L-75-09** JD-P1302 1/3 – SIZE : **263mm x 115mm x 15mm** PACKING : **18PCS/CTN**
- **L-75-10** JD-P1402 1/4 – SIZE : **210mm x 108mm x 15mm** PACKING : **24PCS/CTN**
- **L-75-11** JD-P1602 1/6 – SIZE : **122mm x 107mm x 15mm** PACKING : **36PCS/CTN**

WOODEN PRODUCTS



WOODEN FORK LADLE

- **M-76-01** C-F-12 – SIZE : 12"
- **M-76-02** C-F-15 – SIZE : 15"
- **M-76-03** C-F-17 – SIZE : 17"
- **M-76-04** C-F-24 – SIZE : 24"



WOODEN CAKE LADLE

- **M-76-05** C-L-10 – SIZE : 10"
- **M-76-06** C-L-12 – SIZE : 12"
- **M-76-07** C-L-14 – SIZE : 14"
- **M-76-08** C-L-16 – SIZE : 16"



WOODEN TUNER

- **M-76-09** C-S-12 – SIZE : 12"
- **M-76-10** C-S-15 – SIZE : 15"
- **M-76-11** C-S-17 – SIZE : 17"



WOODEN ROLLER PIN

- **M-76-12** C-R-11 – SIZE : 11"
- **M-76-13** C-R-12 – SIZE : 12"
- **M-76-14** C-R-15 – SIZE : 15.5"
- **M-76-15** C-R-26 – SIZE : 26"



CZECH WOODEN SPOON

- **M-76-16** CQ10 10" – SIZE : L 25cm
- **M-76-17** CQ12 12" – SIZE : L 30cm
- **M-76-18** CQ14 14" – SIZE : L 35cm
- **M-76-19** CQ16 16" – SIZE : L 40cm
- **M-76-20** CQ18 18" – SIZE : L 45cm
- **M-76-21** CQ20 20" – SIZE : L 50cm



M-76-22 PM943

WOODEN HDL POTATO
MASHER –
PACKING : 200PCS/CTN

GLASS WARE

FINE DINING



M-77-01 C18413 MADISON
ROCK – SIZE : TD 6.6 x H 8.5 cm
Capacity : 395 ML



M-77-02 C18414 MADISON HI
BALL – SIZE : TD 6.6 x H 11 cm
Capacity : 390 ML



M-77-03 1015D22 MADISON
BURGUNDY – SIZE : TD 8 x H 20.9 cm
Capacity : 650 ML



M-77-04 1015A21 MADISON
BORDEAUX – SIZE : TD 7.2 x H 22.4 cm
Capacity : 600 ML



M-77-05 1015R15 MADISON RED
WINE – SIZE : TD 6.4 x H 22.4 cm
Capacity : 425 ML



M-77-06 1015W12 MADISON
WHITE WINE – SIZE : TD 6 x H 21 cm
Capacity : 350 ML



M-77-07 1015G15
MADISON WATER
GOBLET – SIZE : TD 6.4
x H 16.6 cm
Capacity : 425 ML



M-77-08 1015L03
MADISON LIQUEUR –
SIZE : TD 4 x H 16.4 cm
Capacity : 85 ML



M-77-09 1015P04
MADISON SHERRY –
SIZE : TD 4.8 x H 18.4 cm
Capacity : 115 ML



M-77-10 B16315
VIVA FOOTED –
SIZE : TD 7 x H 24 cm
Capacity : 420 ML



M-78-01 1015C10
MADISON COCKTAIL –
SIZE : TD 12 x H 19.2 cm
Capacity : 285 ML



M-78-02 1015M12
MADISON MARGARITA –
SIZE : TD 11.6 x H 19 cm
Capacity : 345 ML



M-78-03 1015N22
MADISON COGNAC –
SIZE : TD 7.4 x H 15 cm
Capacity : 650 ML



M-78-04 1015F07
MADISON FLUTE
CHAMPAGNE –
SIZE : TD 4.6 x H 23 cm
Capacity : 210 ML

ALL DAY DINING



M-78-05 B11010 PLAZA
ROCK –
SIZE : TD 8.55 x H 8.9 cm
Capacity : 295 ML



M-78-06 B11011 PLAZA HI BALL –
SIZE : TD 7.05 x H 14 cm
Capacity : 320 ML



M-78-07 B12009 TIARA ROCK –
SIZE : TD 7.8 x H 9.6 cm
Capacity : 270 ML



M-78-08 B12012 TIARA
HI BALL –
SIZE : TD 7.45 x H 13.4 cm
Capacity : 355 ML



M-78-09 B12013 TIARA
ROCK –
SIZE : TD 8.5 x H 10.7 cm
Capacity : 365 ML



M-78-10 B12016 TIARA
LONG DRINK –
SIZE : TD 8.15 x H 14.5 cm
Capacity : 465 ML



M-79-01 B17514 TIARA
FOOTED –
SIZE : TD 7.4 x H 18.5 cm
Capacity : 395 ML

M-79-02 B16910
HAIKU ROCK –
SIZE : TD 8.2 x H 8.8 cm
Capacity : 285 ML

M-79-03 B16911 HAIKU
HI BALL –
SIZE : TD 7.3 x H 11.3 cm
Capacity : 305 ML

M-79-04 B17211 HAIKU
HI BALL –
SIZE : TD 7.3 x H 13.15 cm
Capacity : 310 ML

ICE CREAM CUP



M-79-05 P00116 ALASKA BANANA SPLIT DISH –
SIZE : TD 24.2 x H 4.05 cm



M-79-06 P00115 ALASKA
ICE CREAM CUP –
SIZE : TD 10.05 x H 7.85 cm
Capacity : 205 ML

M-79-07 P00315
ALASKA SUNDAE CUP –
SIZE : TD 10 x H 14.5 cm
Capacity : 225 ML

M-79-08 P00415
ALASKA SODA CUP –
SIZE : TD 7.95 x H 19 cm
Capacity : 355 ML

CASUAL DINING



M-80-01 1503C07 DUCHESS
COCKTAIL – SIZE : TD 11 x H 15.6 cm
Capacity : 210 ML



M-80-02 1503F06 DUCHESS
FLUTE CHAMPAGNE –
SIZE : TD 4.8 x H 20.95 cm
Capacity : 165 ML



M-80-03 P01643 KENYA IRISH
COFFEE –
SIZE : TD 7.4 x H 14.7 cm
Capacity : 230 ML



M-80-04 P01644 KENYA
SLIM MUG –
SIZE : TD 7.2 x H 14.3 cm
Capacity : 320 ML



M-80-05 P01640 KENYA
MUG –
SIZE : TD 8.3 x H 10.3 cm
Capacity : 320 ML



M-80-06 P01641
KENYA CUP –
SIZE : TD 8.5 x H 7.8 cm
Capacity : 245 ML



M-80-07 P01671 KENYA
SAUCER 6" –
SIZE : TD 15 x H 2 cm



M-80-08 P01642 KENYA
ESPRESSO CUP –
SIZE : TD 5.5 x H 5.6 cm
Capacity : 70 ML



M-80-09 P01672 KENYA
ESPRESSO SAUCER 4 1/4" –
SIZE : TD 11 x H 1.8 cm



M-80-10 B16112 STUDIO
ROCK –
SIZE : TD 9.7 x H 9.65 cm
Capacity : 345 ML



M-80-11 B16115 STUDIO
HI BALL –
SIZE : TD 9.2 x H 13.5 cm
Capacity : 435 ML

CATERING & ROOM FUNCTION



M-81-01 1501S05 CLASSIC SAUCER CHAMPAGNE –
SIZE : TD 8.55 x H 10.8 cm
Capacity : 135 ML



M-81-02 FJ-7503 DRINKING JAR

PUB & BAR



M-81-03 1521F06 SALSA FLUTE CHAMPAGNE –
SIZE : TD 4.8 x H 22.4 cm
Capacity : 165 ML



M-81-04 1521C07 SALSA COCKTAIL –
SIZE : TD 4.8 x H 22.4 cm
Capacity : 165 ML



M-81-05 1522H16 CUBA HURRICANE –
SIZE : TD 7.3 x H 18.8 cm
Capacity : 450 ML



M-81-06 R-2 102577 2OZ SHOOTER GLASS –
SIZE : 44mm x 70mm
PACKING : 144PCS/CTN



M-81-07 P00840 MUNICH BEER MUG –
SIZE : TD 7.2 x H 14.1 cm
Capacity : 355 ML



M-81-08 RA-GS-P00840 MUNICH MUG



M-81-09 P00940 BERLINER BEER MUG –
SIZE : TD 6.5 x H 18.5 cm
Capacity : 365 ML

STAINLESS STEEL PRODUCTS

STAINLESS STEEL MESH COLANDER



- **N-82-01 MC25 25CM** - SIZE: Ø 25 cm x H 10 cm
- **N-82-02 MC28 28CM** - SIZE: Ø 28 cm x H 11.5 cm
- **N-82-03 MC31 31CM** - SIZE: Ø 31 cm x H 12.6 cm



STAINLESS STEEL COLANDER WITH TWO HANDLES



- **N-82-04 CH36** - SIZE: D 36 cm
- **N-82-05 CH40** - SIZE: D 40 cm
- **N-82-06 CH45** - SIZE: D 45 cm
- **N-82-07 CH50** - SIZE: D 50 cm

Water can drain easily during washing vegetable by using this colander. The sturdy base keeps food away from the surface of sinks and counter tops.

K3900 SERIES STAINLESS STEEL COLANDER



- **N-83-01** K3920 – SIZE : **D 165mm x H 70mm** THICKNESS: **0.6mm** PACKING : **200PCS/CTN**
- **N-83-02** K3922 – SIZE : **D 185mm x H 75mm** THICKNESS: **0.6mm** PACKING : **120PCS/CTN**
- **N-83-03** K3924 – SIZE : **D 200mm x H 80mm** THICKNESS: **0.6mm** PACKING : **120PCS/CTN**
- **N-83-04** K3926 – SIZE : **D 240mm x H 85mm** THICKNESS: **0.6mm** PACKING : **100PCS/CTN**
- **N-83-05** K3928 – SIZE : **D 255mm x H 91mm** THICKNESS: **0.6mm** PACKING : **100PCS/CTN**
- **N-83-06** K3930 – SIZE : **D 275mm x H 100mm** THICKNESS: **0.6mm** PACKING : **80PCS/CTN**
- **N-83-07** K3932 – SIZE : **D 290mm x H 106mm** THICKNESS: **0.6mm** PACKING : **80PCS/CTN**
- **N-83-08** K3936 – SIZE : **D 310mm x H 125mm** THICKNESS: **0.6mm** PACKING : **60PCS/CTN**
- **N-83-09** K3938 – SIZE : **D 318mm x H 130mm** THICKNESS: **0.6mm** PACKING : **60PCS/CTN**
- **N-83-10** K3940 – SIZE : **D 350mm x H 140mm** THICKNESS: **0.6mm** PACKING : **60PCS/CTN**
- **N-83-11** K3948 – SIZE : **D 420mm x H 160mm** THICKNESS: **0.6mm** PACKING : **6PCS/CTN**
- **N-83-12** K3958 – SIZE : **D 510mm x H 190mm** THICKNESS: **0.6mm** PACKING : **6PCS/CTN**

COLANDER SIEVE



- **N-83-13** RA-KT-CCB-20 – SIZE : **20cm**
- **N-83-14** RA-KT-CCB-22 – SIZE : **22cm**
- **N-83-15** RA-KT-CCB-24 – SIZE : **24cm**
- **N-83-16** RA-KT-CCB-26 – SIZE : **26cm**
- **N-83-17** RA-KT-CCB-28 – SIZE : **28cm**



- **N-83-18** RA-KT-CCH-16 – SIZE : **16.5cm**
- **N-83-19** RA-KT-CCH-19 – SIZE : **19.5cm**
- **N-83-20** RA-KT-CCH-22 – SIZE : **22.5cm**
- **N-83-21** RA-KT-CCH-25 – SIZE : **25.5cm**
- **N-83-22** RA-KT-CCH-28 – SIZE : **28.5cm**
- **N-83-23** RA-KT-CCH-31 – SIZE : **31.5cm**

STAINLESS STEEL SHALLOW DISH W/HOLE



- **N-84-01** MD-200-14 101380 – SIZE : **D140mm**
PACKING : **840PCS/CTN**
- **N-84-02** MD-200-16 101381 – SIZE : **160mm**
PACKING : **560PCS/CTN**
- **N-84-03** MD-200-18 101382 – SIZE : **180mm**
PACKING : **440PCS/CTN**

KOREA MIXING BOWL



Stainless steel mixing bowls are commercial-quality kitchen mixing bowls, sturdy and ready for mixing ingredients for your favorite recipes. Heavy-gauge stainless steel bowls with mirror finish exteriors and flat bottomed.

- **N-84-04** KB34 - SIZE: **D 16 cm x H 5.2 cm** Capacity: **3/4 Qt**
- **N-84-05** KB1 - SIZE: **D 17 cm x H 5.4 cm** Capacity: **1 Qt**
- **N-84-06** KB15 - SIZE: **D 19.5 cm x H 6 cm** Capacity: **1.5 Qt**
- **N-84-07** KB2 - SIZE: **D 21.5 cm x H 6.3 cm** Capacity: **2 Qt**
- **N-84-08** KB3 - SIZE: **D 24 cm x H 7.6 cm** Capacity: **3 Qt**
- **N-84-09** KB4 - SIZE: **D 26 cm x H 7.8 cm** Capacity: **4 Qt**
- **N-84-10** KB5 - SIZE: **D 28 cm x H 8.8 cm** Capacity: **5 Qt**
- **N-84-11** KB6 - SIZE: **D 30 cm x H 9.5 cm** Capacity: **6 Qt**
- **N-84-12** KB8 - SIZE: **D 33 cm x H 9.5 cm** Capacity: **8 Qt**
- **N-84-13** KB10 - SIZE: **D 35.5 cm x H 10.3 cm** Capacity: **10 Qt**
- **N-84-14** KB13 - SIZE: **D 39 cm x H 11.6 cm** Capacity: **13 Qt**
- **N-84-15** KB16 - SIZE: **D 44 cm x H 13.5 cm** Capacity: **16 Qt**
- **N-84-16** KB20 - SIZE: **D 46 cm x H 13.5 cm** Capacity: **20 Qt**

DEEP OVAL PLATTER



- **N-84-17** IN09 – SIZE: **D 20cm**
- **N-84-18** IN05 – SIZE: **D 26 cm**
- **N-84-19** IN06 – SIZE: **D 30 cm**
- **N-84-20** IN07 – SIZE: **D 35 cm**
- **N-84-21** IN08 – SIZE: **D 40 cm**
- **N-84-22** IN10 – SIZE: **D 45 cm**

OVAL BOWL (CURRY DISH)



- **N-85-01** B17 - SIZE: D 17 cm x H 2.7 cm
- **N-85-02** B20 - SIZE: D 20 cm x H 3.3 cm
- **N-85-03** B23 - SIZE: D 23 cm x H 3.8 cm
- **N-85-04** B25 - SIZE: D 25 cm x H 3.8 cm
- **N-85-05** B30 - SIZE: D 30 cm x H 4.5 cm
- **N-85-06** B35 - SIZE: D 35 cm x H 4.7 cm
- **N-85-07** B40 - SIZE: D 40 cm x H 5.3 cm

18.0 S/STEEL STEAMER BOWL



- **N-85-08** 7410 – SIZE : D 100mm x H 80mm
PACKING : 72PCS/CTN
- **N-85-09** 7412 – SIZE : D 120MM X H 82MM
PACKING : 72PCS/CTN
- **N-85-10** 7414 – SIZE : D 140MM X H 90MM
PACKING : 48PCS/CTN
- **N-85-11** 7416 – SIZE : D 160MM X H 100MM
PACKING : 48PCS/CTN
- **N-85-12** 7418 – SIZE : D 180MM X H 110MM
PACKING : 48PCS/CTN

S/STEEL SALAD BOWL



Perfect for salads but also ideal for serving a variety of foods, and for food mixing and preparation. These simple, durable and easy to maintain servers are a kitchen essential.

N-85-13 22586W –
SIZE: D 15"
Capacity: 13.5 L

www.dmhygiene.com.my 018-6660642

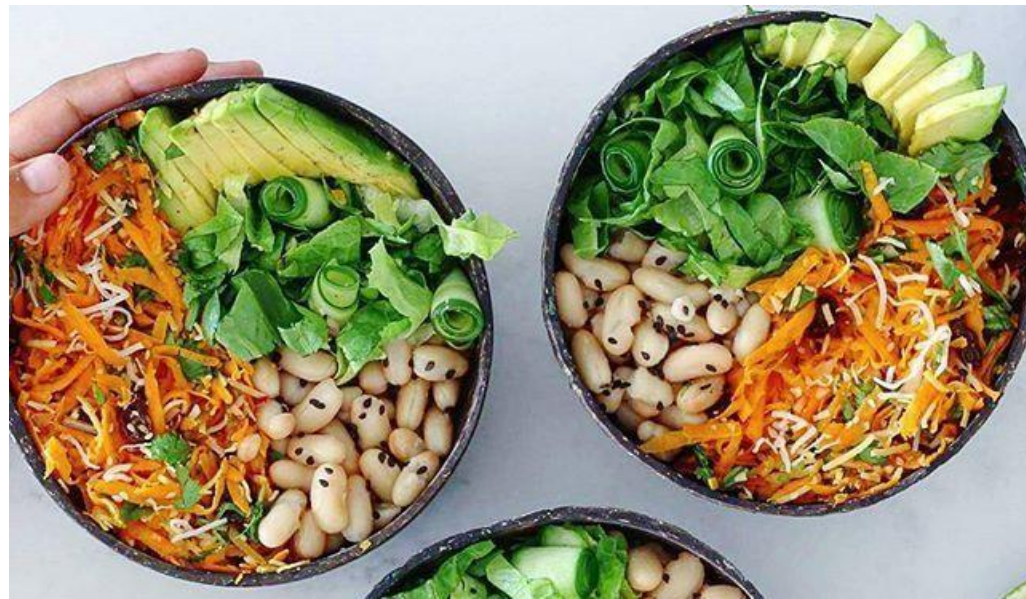

K5400 SERIES STAINLESS STEEL SALAD BOWL



- **N-86-01 K5418** – SIZE : D 180mm x H 88mm THICKNESS : 0.4mm PACKING : 160 PCS/CTN
- **N-86-02 K5420** – SIZE : D 200mm x H 98mm THICKNESS : 0.4mm PACKING : 140 PCS/CTN
- **N-86-03 K5422** – SIZE : D 220mm x H 100mm THICKNESS : 0.4mm PACKING : 120 PCS/CTN
- **N-86-04 K5424** – SIZE : D 240mm x H 109mm THICKNESS : 0.4mm PACKING : 100 PCS/CTN
- **N-86-05 K5426** – SIZE : D 260mm x H 110mm THICKNESS : 0.4mm PACKING : 100 PCS/CTN

K7400 SERIES STAINLESS STEEL SALAD BOWL WITH SILICONE BASE



硅胶底钢沙拉盆
Stainless Steel



- **N-86-06 K7420** – SIZE : D 180mm x H 95mm THICKNESS : 0.4mm PACKING : 140 PCS/CTN
- **N-86-07 K7422** – SIZE : D 200mm x H 100mm THICKNESS : 0.4mm PACKING : 120 PCS/CTN
- **N-86-08 K7424** – SIZE : D 220mm x H 110mm THICKNESS : 0.4mm PACKING : 100 PCS/CTN
- **N-86-09 K7426** – SIZE : D 240mm x H 120mm THICKNESS : 0.4mm PACKING : 100 PCS/CTN
- **N-86-10 K7428** – SIZE : D 260mm x H 130mm THICKNESS : 0.4mm PACKING : 80 PCS/CTN

K6100 SERIES STAINLESS STEEL DOUBLE LAYER SOUP BOWL



- **N-86-11 K6116** – SIZE : D 160mm PACKING : 160 PCS/CTN
- **N-86-12 K6118** – SIZE : D 180mm PACKING : 160 PCS/CTN
- **N-86-13 K6120** – SIZE : D 200mm PACKING : 120 PCS/CTN
- **N-86-14 K6122** – SIZE : D 220mm PACKING : 120 PCS/CTN
- **N-86-15 K6124** – SIZE : D 240mm PACKING : 120 PCS/CTN

K6600 SERIES STAINLESS STEEL DOUBLE LAYER BOWL



- **N-87-01 K6612 – SIZE : D 120mm x H 60mm THICKNESS : 0.32mm PACKING : 30 PACK X 10 UNIT**
- **N-87-02 K6614 – SIZE : D 140mm x H 70mm THICKNESS : 0.32mm PACKING : 24 PACK X 10 UNIT**
- **N-87-03 K6616 – SIZE : D 160mm x H 80mm THICKNESS : 0.32mm PACKING : 18 PACK X 10 UNIT**
- **N-87-04 K6618 – SIZE : D 180mm x H 85mm THICKNESS : 0.32mm PACKING : 18 PACK X 8 UNIT**
- **N-87-05 K6620 – SIZE : D 200mm x H 90mm THICKNESS : 0.32mm PACKING : 12 PACK X 10 UNIT**

18.0 S/STEEL CUP & S/STEEL CUP WITH COVER



- **N-87-06 7410 S/STEEL CUP – SIZE : D 100mm x H 100mm PACKING : 72PCS/CTN**
- **N-87-07 7412 S/STEEL CUP – SIZE : D 120mm x H 120mm PACKING : 72PCS/CTN**
- **N-87-08 7414 S/STEEL CUP – SIZE : D 140mm x H 140mm PACKING : 48PCS/CTN**
- **N-87-09 7416 S/STEEL CUP – SIZE : D 160mm x H 160mm PACKING : 48PCS/CTN**
- **N-87-10 7110 S/STEEL CUP WITH COVER – SIZE : D 100mm x H 100mm PACKING : 72PCS/CTN**
- **N-87-11 7112 S/STEEL CUP WITH COVER – SIZE : D 120mm x H 120mm PACKING : 72PCS/CTN**
- **N-87-12 7114 S/STEEL CUP WITH COVER – SIZE : D 140mm x H 140mm PACKING : 48PCS/CTN**
- **N-87-13 7116 S/STEEL CUP WITH COVER – SIZE : D 160mm x H 160mm PACKING : 48PCS/CTN**

K9600 SERIES STAINLESS STEEL CONDIMENT BOWL LID



- N-88-01 K9610 – SIZE : D 100mm PACKING : 320PCS/CTN
- N-88-02 K9612 – SIZE : D 120mm PACKING : 320PCS/CTN
- N-88-03 K9614 – SIZE : D 140mm PACKING : 320PCS/CTN
- N-88-04 K9616 – SIZE : D 160mm PACKING : 320PCS/CTN
- N-88-05 K9618 – SIZE : D 180mm PACKING : 320PCS/CTN

K7600 SERIES STAINLESS STEEL CONDIMENT BOWL



- N-88-06 K7610 – SIZE : D 100mm x H 75mm PACKING : 500PCS/CTN
- N-88-07 K7612 – SIZE : D 120mm x H 87mm PACKING : 320PCS/CTN
- N-88-08 K7614 – SIZE : D 140mm x H 92mm PACKING : 200PCS/CTN
- N-88-09 K7616 – SIZE : D 160mm x H 102mm PACKING : 160PCS/CTN
- N-88-10 K7618 – SIZE : D 180mm x H 110mm PACKING : 120PCS/CTN

K2900 SERIES STAINLESS STEEL PERFORATED BASKET



- N-88-11 K2929 – SIZE : L 295mm x W 220mm x H 50mm PACKING : 100PCS/CTN
- N-88-12 K2937 – SIZE : L 375mm x W 275mm x H 65mm PACKING : 100PCS/CTN

KO200 SERIES STAINLESS STEEL RECTANGULAR TRAY



- N-89-01 K0227 – SIZE : L 200 x W 270mm x H 20mm THICKNESS : 0.5mm PACKING : 80 PCS/CTN
- N-89-02 K0232 – SIZE : L 220 x W 320mm x H 20mm THICKNESS : 0.5mm PACKING : 80 PCS/CTN
- N-89-03 K0236 – SIZE : L 270 x W 360mm x H 20mm THICKNESS : 0.5mm PACKING : 80 PCS/CTN
- N-89-04 K0240 – SIZE : L 300 x W 400mm x H 20mm THICKNESS : 0.5mm PACKING : 40 PCS/CTN
- N-89-05 K0245 – SIZE : L 350 x W 450mm x H 20mm THICKNESS : 0.5mm PACKING : 40 PCS/CTN
- N-89-06 K0250 – SIZE : L 350 x W 500mm x H 20mm THICKNESS : 0.5mm PACKING : 40 PCS/CTN
- N-89-07 K0260 – SIZE : L 400 x W 600mm x H 20mm THICKNESS : 0.5mm PACKING : 40 PCS/CTN

KO400 SERIES STAINLESS STEEL RECTANGULAR TRAY

(DEEP)



- N-89-08 K0427 – SIZE : L 200 x W 270mm x H 48mm THICKNESS : 0.6mm PACKING : 80 PCS/CTN
- N-89-09 K0432 – SIZE : L 220 x W 320mm x H 48mm THICKNESS : 0.6mm PACKING : 80 PCS/CTN
- N-89-10 K0436 – SIZE : L 270 x W 360mm x H 48mm THICKNESS : 0.6mm PACKING : 80 PCS/CTN
- N-89-11 K0440 – SIZE : L 300 x W 400mm x H 48mm THICKNESS : 0.6mm PACKING : 40 PCS/CTN
- N-89-12 K0445 – SIZE : L 350 x W 450mm x H 48mm THICKNESS : 0.6mm PACKING : 40 PCS/CTN
- N-89-13 K0450 – SIZE : L 350 x W 500mm x H 48mm THICKNESS : 0.6mm PACKING : 40 PCS/CTN
- N-89-14 K0460 – SIZE : L 400 x W 600mm x H 48mm THICKNESS : 0.6mm PACKING : 40 PCS/CTN

K7300 SERIES STAINLESS STEEL FOOD TRAY



- N-90-01 K7325 – SIZE : L 195mm x W 250mm x H 50mm THICKNESS : 0.6mm PACKING : 48 PCS/CTN
- N-90-02 K7330 – SIZE : L 240 x W 300mm x H 50mm THICKNESS : 0.6mm PACKING : 36 PCS/CTN
- N-90-03 K7335 – SIZE : L 275 x W 350mm x H 50mm THICKNESS : 0.6mm PACKING : 36 PCS/CTN
- N-90-04 K7340 – SIZE : L 300 x W 400mm x H 50mm THICKNESS : 0.6mm PACKING : 24 PCS/CTN

INDIA S/STEEL DEEP ROUND TRAY

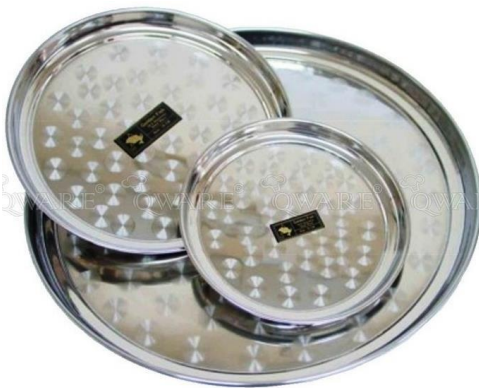

- N-90-05 INRT020 – SIZE : D 25 cm
- N-90-06 INRT021 – SIZE : D 30 cm
- N-90-07 INRT022 – SIZE : D 35 cm
- N-90-08 INRT023 – SIZE : D 40 cm
- N-90-09 INRT024 – SIZE : D 45cm
- N-90-10 INRT025 – SIZE : D 50cm

STEEL TRAY



- N-90-11 HL-SS-TR3627 – SIZE : 14" x 10.5"
- N-90-12 HL-SS-TR4834 – SIZE : 19" x 13"
- N-90-13 HL-SS-TR5842 – SIZE : 23.5" x 15.5"



- N-90-14 RA-SS-TR1723 – SIZE : 17cm x 23cm
- N-90-15 RA-SS-TR2026 – SIZE : 20cm x 26cm
- N-90-16 RA-SS-TR2431 – SIZE : 24cm x 31cm
- N-90-17 RA-SS-TR3040 – SIZE : 30cm x 40cm

K3000 SERIES 18.8 STAINLESS STEEL FLOUR STRAINER (WITHOUT RING)



- N-91-01 K3020 – SIZE : D 200mm x H 57mm PACKING : 48PCS/CTN
- N-91-02 K3025 – SIZE : D 250mm x H 57mm PACKING : 48PCS/CTN
- N-91-03 K3030 – SIZE : D 300mm x H 57mm PACKING : 24PCS/CTN

WOODEN HDL S/STEEL NOODLE DRAINER



N-91-04 WND14– SIZE : D 14cm x H 34cm PACKING : 100PCS/CTN

NOODLE STRAINER



- N-91-05 RA-KT-NS-A12 – SIZE : 12cm
- N-91-06 RA-KT-NS-A14 – SIZE : 14cm
- N-91-07 RA-KT-NS-A16 – SIZE : 16cm

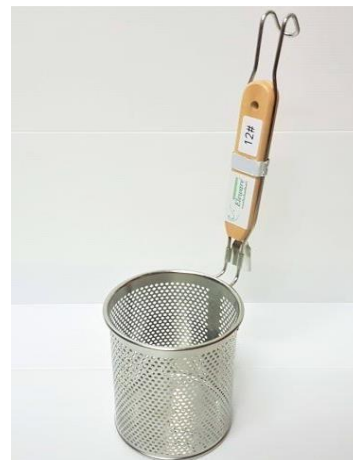

- N-91-08 RA-KT-NS-B12 – SIZE : 12cm
- N-91-09 RA-KT-NS-B14 – SIZE : 14cm
- N-91-10 RA-KT-NS-B16 – SIZE : 16cm

S/STEEL HIGH SHAPE OIL STRAINER



- **N-92-01** Y0802 – SIZE : **21cm** PACKING : **50PCS/CTN**
- **N-92-02** Y0803 – SIZE : **25cm** PACKING : **50PCS/CTN**
- **N-92-03** Y0804 – SIZE : **28cm** PACKING : **50PCS/CTN**

S/STEEL OIL STRAINER



- **N-92-04** Y1201 – SIZE : **15.5cm** PACKING : **300PCS/CTN**
- **N-92-05** Y1202 – SIZE : **18cm** PACKING : **150PCS/CTN**
- **N-92-06** Y1203 – SIZE : **20cm** PACKING : **150PCS/CTN**
- **N-92-07** Y1204 – SIZE : **22cm** PACKING : **150PCS/CTN**
- **N-92-08** Y1205 – SIZE : **25cm** PACKING : **100PCS/CTN**

K6200 SERIES STAINLESS STEEL SHALLOW SIEVE



- **N-92-09** K6215 – SIZE : **D 150mm**
PACKING : **12PCS/PACK (6 PACK X 50 UNIT)**
- **N-92-10** K6217 – SIZE : **D 170mm**
PACKING : **12PCS/PACK (6 PACK X 50 UNIT)**
- **N-92-11** K6220 – SIZE : **D 200mm**
PACKING : **12PCS/PACK (15 PACK X 10 UNIT)**
- **N-92-12** K6222 – SIZE : **D 225mm**
PACKING : **12PCS/PACK (15 PACK X 10 UNIT)**
- **N-92-13** K6225 – SIZE : **D 250mm**
PACKING : **12PCS/PACK (10 PACK X 10 UNIT)**

K4000 SERIES STAINLESS STEEL STRAINER



- **N-93-01 K014 – SIZE : D 140mm PACKING : 15 PACK X 12 UNIT**
- **N-93-02 K016 – SIZE : D 160mm PACKING : 15 PACK X 12 UNIT**
- **N-93-03 K018 – SIZE : D 180mm PACKING : 15 PACK X 12 UNIT**
- **N-93-04 K020 – SIZE : D 200mm PACKING : 15 PACK X 12 UNIT**
- **N-93-05 K022 – SIZE : D 220mm PACKING : 15 PACK X 12 UNIT**

WIRE STRAINER



- **N-93-06 RA-KT-318-P60 – SIZE : 6cm**
- **N-93-07 RA-KT-318-P80 – SIZE : 8cm**
- **N-93-08 RA-KT-318-P95 – SIZE : 9.5cm**

STEEL STRAINER



- **N-93-09 RA-KT-SYC-16 – SIZE : 16cm**
- **N-93-10 RA-KT-SYC-18 – SIZE : 18cm**
- **N-93-11 RA-KT-SYC-20 – SIZE : 20cm**

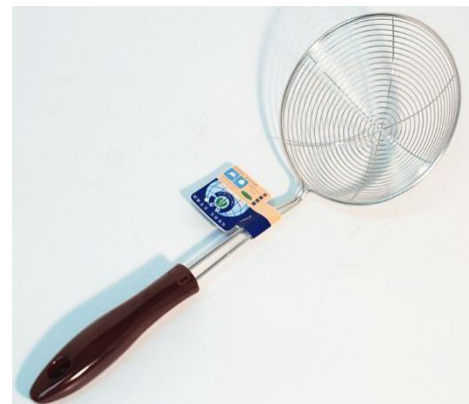

- **N-93-12 RA-KT-SY-16 – SIZE : 16cm**
- **N-93-13 RA-KT-SY-18 – SIZE : 18cm**
- **N-93-14 RA-KT-SY-20 – SIZE : 20cm**
- **N-93-15 RA-KT-SY-22 – SIZE : 22cm**

STAINLESS STEEL HOOK LADLE



- N-94-01 L01/2 – SIZE : D 5cm x L 25cm Capacity : ½ Oz
- N-94-02 L01 – SIZE : D 6cm x L 30cm Capacity : 1 Oz
- N-94-03 L02 – SIZE : D 7cm x L 32.2cm Capacity : 2 Oz
- N-94-04 L03 – SIZE : D 7.5cm x L 32.5cm Capacity : 3 Oz
- N-94-05 L04 – SIZE : D 8.3cm x L 36cm Capacity : 4 Oz
- N-94-06 L05 – SIZE : D 9cm x L 37cm Capacity : 5 Oz
- N-94-07 L06 – SIZE : D 9.2cm x L 37cm Capacity : 6 Oz
- N-94-08 L07 – SIZE : D 10cm x L 37cm Capacity : 7 Oz
- N-94-09 L08 – SIZE : D 10.2cm x L 37cm Capacity : 8 Oz
- N-94-10 L010 – SIZE : D 11cm x L 38cm Capacity : 10 Oz
- N-94-11 L012 – SIZE : D 11.5cm x L 38cm Capacity : 12 Oz

A soup ladle is a specialized spoon which is designed for serving soups, gravies, punches, and other liquids. Ladles can also be used for stirring and in food preparation.

S/STEEL WOK LADLE



- N-94-12 HML1# – PACKING : 100PCS/CTN
- N-94-13 HML2# – PACKING : 100PCS/CTN
- N-94-14 HML3# – PACKING : 100PCS/CTN
- N-94-15 HML4# – PACKING : 100PCS/CTN
- N-94-16 HML5# – PACKING : 100PCS/CTN

OIL LADLE



N-94-17 HL-TR-06(X11-06) – SIZE : 6CM

STAINLESS STEEL SOUP LADLE



N-94-18 SL-7 – SIZE : D 7 cm

A soup ladle is a specialized spoon which is designed for serving soups, gravies, punches, and other liquids. Ladles can also be used for stirring and in food preparation. The hole on the handle designed for easy storage by hang it on the wall in order to keep dry and clean.

STAINLESS STEEL PERFORATED SOUP LADLE



N-95-01 SL-7P – SIZE : D 7 cm

A slotted ladle for lifting cooked food from liquids, which drains through the perforations. The hole on the handle designed for easy storage by hang it on the wall in order to keep dry and clean.

S/STEEL FRYING LADLE



- **N-95-02 216 – SIZE : D 160mm x L 400mm**
PACKING : 180PCS/CTN
- **N-95-03 218 – SIZE : D 180mm x L 420mm**
PACKING : 120PCS/CTN

S/STEEL FUJI LADLE



- **N-95-04 HL-F-0 NO.0 – SIZE : 8.5CM**
- **N-95-05 HL-F-1 NO.1 – SIZE : 8CM**
- **N-95-06 HL-F-2 NO.2 – SIZE : 7CM**
- **N-95-07 HL-F-3 NO.3 – SIZE : 6.5CM**
- **N-95-08 HL-F-4 NO.4 – SIZE : 5.5CM**

S/STEEL WATER LADLE



- **N-95-09 209 – SIZE : D 90mm x L 330mm x H 90mm**
PACKING : 36PCS/CTN
- **N-95-10 210 – SIZE : D 100mm x L 330mm x H 100mm**
PACKING : 36PCS/CTN

S/STEEL WOK TURNER



- **N-95-11 HMT1# – PACKING : 100PCS/CTN**
- **N-95-12 HMT2# – PACKING : 100PCS/CTN**
- **N-95-13 HMT3# – PACKING : 100PCS/CTN**
- **N-95-14 HMT4# – PACKING : 100PCS/CTN**
- **N-95-15 HMT5# – PACKING : 100PCS/CTN**

K1800 SERIES STAINLESS STEEL SKIMMER



- N-96-01 K1826 – SIZE : D 260mm x L 455mm PACKING : 50 PCS/CTN
- N-96-02 K1828 – SIZE : D 280mm x L 470mm PACKING : 50 PCS/CTN
- N-96-03 K1830 – SIZE : D 300mm x L 490mm PACKING : 50 PCS/CTN

S/STEEL MILK JUG



- N-96-04 SMJ350 – Capacity : 350ml PACKING : 50PCS/CTN
- N-96-05 SMJ600 – Capacity : 600ml PACKING : 50PCS/CTN
- N-96-06 SMJ1000 – Capacity : 1000ml PACKING : 60PCS/CTN
- N-96-07 SMJ1500 – Capacity : 1500ml PACKING : 48PCS/CTN
- N-96-08 SMJ2000 – Capacity : 2000ml PACKING : 36PCS/CTN

DEEP KOPI MUG IPOH



N-96-09 SS004 - SIZE : 5" X 6"

S/S KOPI MUG MULUT



N-96-10 SIZE : 12 cm

IPOH S/S TEA POT



- N-96-11 SIZE : LARGE
- N-96-12 SIZE : SMALL

POURING CONE



- N-96-13 HL-Z-PC-01 – SIZE : 15cm
- N-96-14 HL-Z-PC-02 – SIZE : 11.5cm

S/STEEL FOOD CARRIER

www.dmhygiene.com.my 018-6660642



- N-97-01 122 – SIZE : D 120mm x H 110mm/2 PACKING : 24PCS/CTN
- N-97-02 123 – SIZE : D 120mm x H 160mm/3 PACKING : 24PCS/CTN
- N-97-03 124 – SIZE : D 120mm x H 210mm/4 PACKING : 12PCS/CTN
- N-97-04 141 – SIZE : D 140mm x H 65mm/1 PACKING : 24PCS/CTN
- N-97-05 142 – SIZE : D 140mm x H 130mm/2 PACKING : 24PCS/CTN
- N-97-06 143 – SIZE : D 140mm x H 190mm/3 PACKING : 24PCS/CTN
- N-97-07 144 – SIZE : D 140mm x H 250mm/4 PACKING : 12PCS/CTN
- N-97-08 162 – SIZE : D 160mm x H 205mm/2 PACKING : 24PCS/CTN
- N-97-09 163 – SIZE : D 160mm x H 245mm/3 PACKING : 12PCS/CTN
- N-97-10 164 – SIZE : D 160mm x H 270mm/4 PACKING : 12PCS/CTN



ADJUSTABLE S/STEEL SALT/ PEPPER SHAKER



- **N-98-01** H0509(ASPSS) – SIZE : S
PACKING : **480 PCS/CTN**
- **N-98-02** H0508(ASPSM) – SIZE : M
PACKING : **144 PCS/CTN**
- **N-98-03** H0507(ASPSL) – SIZE : L
PACKING : **144 PCS/CTN**

S/STEEL SALT/ PEPPER SHAKER



- **N-98-04** H0505(SPSS) – SIZE : S
PACKING : **480 PCS/CTN**
- **N-98-05** H0504(SPSM) – SIZE : M
PACKING : **144 PCS/CTN**
- **N-98-06** H0503(SPSL) – SIZE : L
PACKING : **144 PCS/CTN**

S/STEEL PEPPER SHAKER



N-98-07 H0826 – PACKING : **100 PCS/CTN**

S/STEEL PERFORATED SESAME SHAKER



N-98-08 H0621 3.5MM – PACKING : **144 PCS/CTN**

S/STEEL THICK EGG WHISK

www.dmhygiene.com.my 018-6660642



- **N-99-01 EW8S – SIZE : 8" PACKING : 60PCS /CTN**
- **N-99-02 EW10 – SIZE : 10" PACKING : 60PCS /CTN**
- **N-99-03 EW12 – SIZE : 12" PACKING : 60PCS /CTN**
- **N-99-04 EW14 – SIZE : 14" PACKING : 60PCS /CTN**
- **N-99-05 EW16 – SIZE : 16" PACKING : 60PCS /CTN**
- **N-99-06 EW18 – SIZE : 18" PACKING : 60PCS /CTN**
- **N-99-07 EW20 – SIZE : 20" PACKING : 60PCS /CTN**
- **N-99-08 EW22 – SIZE : 22" PACKING : 60PCS /CTN**

The wires are bent teardrop-shaped and very elastic. With a whisk and whip cream to make light creams, it is suitable for producing eggs and cunning of eggs, whipping egg whites to stiff and for mixing sauces of all kinds.

S/STEEL WIRE WHISK



- **N-99-09 W008 – SIZE : 8" PACKING : 72 PCS /CTN**
- **N-99-10 W010 – SIZE : 10" PACKING : 72 PCS /CTN**

EGG WHISK



- **N-99-11 RA-KT-1008-08 (1 MM) – SIZE : 8"**
- **N-99-12 RA-KT-1008-10 (1 MM) – SIZE : 10"**
- **N-99-13 RA-KT-1008-12 (1 MM) – SIZE : 12"**



STEAM PLATE



- **N-100-01** RA-SS-SP-16 – SIZE : **16cm**
- **N-100-02** RA-SS-SP-18 – SIZE : **18cm**
- **N-100-03** RA-SS-SP-20 – SIZE : **20cm**
- **N-100-04** RA-SS-SP-22 – SIZE : **22cm**
- **N-100-05** RA-SS-SP-24 – SIZE : **24cm**
- **N-100-06** RA-SS-SP-26 – SIZE : **26cm**
- **N-100-07** RA-SS-SP-28 – SIZE : **28cm**
- **N-100-08** RA-SS-SP-30 – SIZE : **30cm**
- **N-100-09** RA-SS-SP-32 – SIZE : **32cm**
- **N-100-10** RA-SS-SP-34 – SIZE : **34cm**
- **N-100-11** RA-SS-SP-36 – SIZE : **36cm**
- **N-100-12** RA-SS-SP-38 – SIZE : **38cm**
- **N-100-13** RA-SS-SP-40 – SIZE : **40cm**
- **N-100-14** RA-SS-SP-42 – SIZE : **42cm**
- **N-100-15** RA-SS-SP-44 – SIZE : **44cm**
- **N-100-16** RA-SS-SP-46 – SIZE : **46cm**
- **N-100-17** RA-SS-SP-48 – SIZE : **48cm**
- **N-100-18** RA-SS-SP-50 – SIZE : **50cm**
- **N-100-19** RA-SS-SP-52 – SIZE : **52cm**
- **N-100-20** RA-SS-SP-54 – SIZE : **54cm**
- **N-100-21** RA-SS-SP-56 – SIZE : **56cm**
- **N-100-22** RA-SS-SP-58 – SIZE : **58cm**
- **N-100-23** RA-SS-SP-60 – SIZE : **60cm**
- **N-100-24** RA-SS-SP-62 – SIZE : **62cm**

H8000 SERIES STAINLESS STEEL ROUND STOOL



- **N-100-25** H8025 – SIZE : **W 291mm x H 250mm** PACKING : **14 PCS/CTN**
- **N-100-26** H8030 – SIZE : **W 291mm x H 298mm** PACKING : **14 PCS/CTN**
- **N-100-27** H8047 – SIZE : **W 291mm x H 468mm** PACKING : **12 PCS/CTN**



N-101-01 134102 STAINLESS STEEL KIDNEY SHAPE WASTE CONTAINER –
SIZE : L 35.5 cm x H 8 cm



STAINLESS STEEL FUNNEL

- **N-101-02** FU-2116 –
SIZE : Ø 16.4 cm x H 13.2 cm
- **N-101-03** FU-2118 –
SIZE : Ø 18.5 cm x H 16.8 cm
- **N-101-04** FU-2120 –
SIZE : Ø 20.5 cm x H 17.8 cm



N-101-05 9041 SENDUK 3 KATI



S/STEEL GRAVY BOAT

- **N-101-05** GB85 – Capacity : 3 Oz
PACKING : 24PCS/CTN
- **N-101-06** GB140 – Capacity : 5 Oz
PACKING : 24PCS/CTN
- **N-101-07** GB230 – Capacity : 8 Oz
PACKING: 24PCS/CTN
- **N-101-08** GB280 – Capacity : 10 Oz
PACKING : 24PCS/CTN
- **N-101-09** GB460 – Capacity : 16 Oz
PACKING : 24PCS/CTN



N-101-11 TZ-5-1 S/S BONE CLIPPER – SIZE : L 11cm



N-101-10 WES116 STAINLESS STEEL WIRE EGG SLICER –
SIZE : L 13.9 cm x W 9.3 cm x H 2.1 cm



N-101-12 PL4-6 SQUARE S/S SIX HOLE ESCARGOT PLATE –
SIZE : L 17.5 cm x W 17.5 cm



N-101-13 PT19 S/S FRENCH FRY SCOOP –
SIZE : L 23 cm x W 18.5 cm



N-101-14 WS-2# 2# S/STEEL WOK STAND – SIZE : 28cm x H 5.5cm
PACKING : 200PCS/CTN



N-102-04 9002 15" TONG MEE (U)



N-102-06 9137 15" TONG YONG TAU FU

- **N-102-01 9003 15" TONG MEE KOSONG**
- **N-102-02 9001 15" TONG MEE 2 PETAK**
- **N-102-03 9004 15" TONG MEE 3 PETAK**



S/STEEL 3 HEAD DUCK HOOKS

- **N-102-09 SH-105 100789 – SIZE : 5" PACKING : 100PCS/CTN**
- **N-102-10 SH-107 100790 – SIZE : 7" PACKING : 100PCS/CTN**
- **N-102-11 SH-109 100791 – SIZE : 9" PACKING : 100PCS/CTN**



S/STEEL "S" HOOKS

- **N-102-12 SH-04 102217 – SIZE : 4" PACKING : 250PCS/CTN**
- **N-102-13 SH-05 102218 – SIZE : 5" PACKING : 250PCS/CTN**
- **N-102-14 SH-06 100776 – SIZE : 6" PACKING : 250PCS/CTN**
- **N-102-15 SH-07 100777 – SIZE : 7" PACKING : 250PCS/CTN**
- **N-102-16 SH-08 100778 – SIZE : 8" PACKING : 250PCS/CTN**
- **N-102-17 SH-09 100779 – SIZE : 9" PACKING : 250PCS/CTN**



- **N-102-07 9026 17" TONG KOPI**
- **N-102-08 9027 18" TONG KOPI**



S/STEEL PIN WITH RING

- **N-102-18 SH-1016 100780 – PACKING : 100PCS/CTN**
- **N-102-19 SH-1018 100781 – PACKING : 100PCS/CTN**

STAINLESS STEEL MINI WOK



- **N-102-20 MW-8 100598 – SIZE : 8" PACKING : 100PCS/CTN**
- **N-102-21 MW-9 100599 – SIZE : 9" PACKING : 100PCS/CTN**
- **N-102-22 MW-10 100601 – SIZE : 10" PACKING : 100PCS/CTN**

STAINLESS STEEL SPARK-L

www.dmhygiene.com.my 018-6660642



- **N-103-01** YH-SC01 JAPAN MODEL SPARK-L LIGHTER (M) – SIZE : **30cm** PACKING : **144PCS**
- **N-103-02** YH-071666 JAPAN MODEL SPARK-L LIGHTER (L) – SIZE : **37cm** PACKING : **144PCS**



- **N-103-03** YH-560 JAPAN MODEL SPARK-L LIGHTER (XL) – SIZE : **56cm** PACKING : **144PCS**



- **N-103-04** TKT9607 MULTI-PURPOSE TORCH – PACKING : **100PCS**



- **N-103-05** WS-511 MULTI-PURPOSE TORCH – PACKING : **100PCS**



MEAT SLICER WITH STAINLESS STEEL BLADE



Feature:

- Skid proof rubber feet secure the slicer on the counter-top while slicing.
- Creates a more consistent, even product.
- On-off switch with waterproof cover
- Easy to clean and maintenance
- Fixed Device Handle for Pushing the Fixed Meat to Slice
- 1 additional whetstone and 1 additional belt

MS-6SS 200W Meat Slicer (Silver Base) with Stainless Steel Blade –

- SIZE : **L 5.5" X W 7.5" X H 4.5"**
- BLADE DIAMETER : **7.67"**
- VOLTAGE : **110V/ 60HZ**
- ROTARY SPEED : **510 r/min**

The Kitchenware Station MS-6SS high quality stainless steel blade professional semi- automatic meat food slicer is perfect for home use, caterers and chefs etc. MS-6SS features a compact design, its overall dimensions are 15.2" (L) * 14.8" (W) *13" (H). This meat slicer feature 200 watts of motor power, it is perfect for slicing meats(recommended), vegetables, cheeses and fruits smoothly, quickly and effortlessly up to .4" thick (0-10mm) with the numerical scale knob. MS-6SS also has a built-in dual whetstones sharpener and ring guard assembly for the blade, which is more convenient to keep a razor sharp edge on the blade, and safer to use. The slicer's blade of Kitchenware Station MS-6SS in silver is constructed of high quality stainless steel; and the body of MS-6SS is made of aluminum alloy which are more durable and less likely to corrode.



S/STEEL POT

03 STYLE SANDWICH BOTTOM S/STEEL STOCK POT



- **N-106-01 SPT-2020** – SIZE : **D200mm x H200mm** Capacity : **6 L** PACKING : **1 PCS/CTN**
- **N-106-02 SPT-2525** – SIZE : **D250mm x H250mm** Capacity : **12 L** PACKING : **1 PCS/CTN**
- **N-106-03 SPT-2828** – SIZE : **D280mm x H280mm** Capacity : **18 L** PACKING : **1 PCS/CTN**
- **N-106-04 SPT-3030** – SIZE : **D300mm x H300mm** Capacity : **22 L** PACKING : **1 PCS/CTN**
- **N-106-05 SPT-3232** – SIZE : **D320mm x H320mm** Capacity : **27 L** PACKING : **1 PCS/CTN**
- **N-106-06 SPT-3636** – SIZE : **D360mm x H360mm** Capacity : **38 L** PACKING : **1 PCS/CTN**
- **N-106-07 SPT-4040** – SIZE : **D400mm x H400mm** Capacity : **52 L** PACKING : **1 PCS/CTN**
- **N-106-08 SPT-4545** – SIZE : **D450mm x H450mm** Capacity : **75 L** PACKING : **1 PCS/CTN**
- **N-106-09 SPT-5050** – SIZE : **D500mm x H500mm** Capacity : **100 L** PACKING : **1 PCS/CTN**
- **N-106-10 SPT-6060** – SIZE : **D600mm x H600mm** Capacity : **170 L** PACKING : **1 PCS/CTN**

03 STYLE SANDWICH BOTTOM S/STEEL SAUCE POT



- **N-106-11 LSP-3020** – SIZE : **D300mm x H200mm** Capacity : **15 L** PACKING : **1 PCS/CTN**
- **N-106-12 LSP-3222** – SIZE : **D320mm x H220mm** Capacity : **18 L** PACKING : **1 PCS/CTN**
- **N-106-13 LSP-3624** – SIZE : **D360mm x H240mm** Capacity : **25 L** PACKING : **1 PCS/CTN**
- **N-106-14 LSP-4026** – SIZE : **D400mm x H260mm** Capacity : **35 L** PACKING : **1 PCS/CTN**
- **N-106-15 LSP-4528** – SIZE : **D450mm x H280mm** Capacity : **47 L** PACKING : **1 PCS/CTN**
- **N-106-16 LSP-5030** – SIZE : **D500mm x H300mm** Capacity : **62 L** PACKING : **1 PCS/CTN**

O3 STYLE DOUBLE HANDLE SANDWICH BOTTOM S/STEEL CASSEROLE POT



- **N-107-01** CP3212D – SIZE : **D320mm x H120mm**
Capacity : **10 L** PACKING : **1PCS/CTN**
- **N-107-02** CP3614D – SIZE : **D360mm x H140mm**
Capacity : **14 L** PACKING : **1PCS/CTN**
- **N-107-03** CP4015D – SIZE : **D400mm x H150mm**
Capacity : **18 L** PACKING : **1PCS/CTN**
- **N-107-04** CP4517D – SIZE : **D450mm x H170mm**
Capacity : **27 L** PACKING : **1PCS/CTN**

O3 STYLE DOUBLE HANDLE SANDWICH BOTTOM S/STEEL SAUCE POT



- **N-107-05** LSP-14085D – SIZE : **D140mm x H85mm** Capacity : **1 L** PACKING : **8 PCS/CTN**
- **N-107-06** LSP-16100D – SIZE : **D160mm x H100mm** Capacity : **1.8 L** PACKING : **4 PCS/CTN**
- **N-107-07** LSP-18110D – SIZE : **D180mm x H110mm** Capacity : **2.4 L** PACKING : **4 PCS/CTN**
- **N-107-08** LSP-20125D – SIZE : **D200mm x H125mm** Capacity : **3 L** PACKING : **4 PCS/CTN**
- **N-107-09** LSP-24140D – SIZE : **D240mm x H140mm** Capacity : **5.8 L** PACKING : **4 PCS/CTN**
- **N-107-10** LSP-26150D – SIZE : **D260mm x H150mm** Capacity : **7 L** PACKING : **4 PCS/CTN**
- **N-107-11** LSP-28160D – SIZE : **D280mm x H160mm** Capacity : **8.5 L** PACKING : **4 PCS/CTN**
- **N-107-12** LSP-30180D – SIZE : **D300mm x H180mm** Capacity : **12.5 L** PACKING : **4 PCS/CTN**
- **N-107-13** LSP-32180D – SIZE : **D320mm x H180mm** Capacity : **14.5 L** PACKING : **4 PCS/CTN**

03 STYLE SANDWICH BOTTOM S/STEEL SAUCE POT



- **N-108-01** SP-16095 – SIZE : **D160mm x H95mm** Capacity : **1.8L** PACKING : **4 PCS/CTN**
- **N-108-02** SP-18110 – SIZE : **D180mm x H110mm** Capacity : **2.4L** PACKING : **4 PCS/CTN**
- **N-108-03** SP-20215 – SIZE : **D200mm x H125mm** Capacity : **3L** PACKING : **4 PCS/CTN**
- **N-108-04** SP-22135 – SIZE : **D220mm x H135mm** Capacity : **4L** PACKING : **4 PCS/CTN**
- **N-108-05** SP-24140 – SIZE : **D240mm x H140mm** Capacity : **5.8L** PACKING : **4 PCS/CTN**

03 STYLE SANDWICH BOTTOM S/STEEL SAUCE POT WITH HELPER HDL



- **N-108-06** SP-26150HD – SIZE : **D260mm x H150mm** Capacity : **7L** PACKING : **2 PCS/CTN**
- **N-108-07** SP-28160HD – SIZE : **D280mm x H160mm** Capacity : **8.5L** PACKING : **2 PCS/CTN**
- **N-108-08** SP-30180HD – SIZE : **D300mm x H180mm** Capacity : **11L** PACKING : **2 PCS/CTN**

DOUBLE HDL S/STEEL SAUCE POT



- **N-108-09** WSP-22 - SIZE : **22cm** PACKING : **50 PCS/CTN**
- **N-108-10** WSP-24 - SIZE : **24cm** PACKING : **50 PCS/CTN**
- **N-108-11** WSP-26 - SIZE : **26cm** PACKING : **40 PCS/CTN**
- **N-108-12** WSP-28 - SIZE : **28cm** PACKING : **40 PCS/CTN**

03 STYLE SANDWICH BOTTOM S/STEEL SAUTE POT



- **N-109-01** SAU-1660 – SIZE : **D160mm x H60mm** Capacity : **0.9L**
PACKING : **4PCS/CTN**
- **N-109-02** SAU-1865 – SIZE : **D180mm x H65mm** Capacity : **1.2L**
PACKING : **4PCS/CTN**
- **N-109-03** SAU-2070 – SIZE : **D200mm x H70mm** Capacity : **2L**
PACKING : **4PCS/CTN**
- **N-109-04** SAU-2275 – SIZE : **D220mm x H75mm** Capacity : **2.3L**
PACKING : **4PCS/CTN**
- **N-109-05** SAU-2480 – SIZE : **D240mm x H80mm** Capacity : **3.6L**
PACKING : **2PCS/CTN**

03 STYLE SANDWICH BOTTOM S/STEEL SAUTE POT WITH HELPER HDL



- **N-109-06** SAU-2685 – SIZE : **D260mm x H85mm** Capacity : **3.8L**
PACKING : **2PCS/CTN**

STAINLESS STEEL STOCK POT



- **N-109-07** 2625 – SIZE : **Ø25cm x H25cm**
Capacity : **12 L** PACKING : **24PCS/CTN**
- **N-109-08** 2630 – SIZE : **Ø30cm x H30cm**
Capacity : **22 L** PACKING : **12PCS/CTN**
- **N-109-09** 2635 – SIZE : **Ø35cm x H35cm**
Capacity : **35 L** PACKING : **10PCS/CTN**
- **N-109-10** 2640 – SIZE : **Ø40cm x H40cm**
Capacity : **52 L** PACKING : **8 PCS/CTN**
- **N-109-11** 2645 – SIZE : **Ø45cm x H45cm**
Capacity : **73 L** PACKING : **6 PCS/CTN**
- **N-109-12** 2650 – SIZE : **Ø50cm x H50cm**
Capacity : **100 L** PACKING : **5PCS/CTN**
- **N-109-13** 2660 – SIZE : **Ø60cm x H60cm**
Capacity : **172 L** PACKING : **3PCS/CTN**

S/STEEL DOUBLE HANDLE COOKING POT



- **N-110-01** 8416/8016 – SIZE : D 160mm x H 90mm PACKING : 12PCS/CTN
- **N-110-02** 8418/8018 – SIZE : D 180mm x H 100mm PACKING : 12PCS/CTN
- **N-110-03** 8420/8020 – SIZE : D 200mm x H 110mm PACKING : 12PCS/CTN
- **N-110-04** 8422/8022 – SIZE : D 220mm x H 125mm PACKING : 12PCS/CTN
- **N-110-05** 8424/8024 – SIZE : D 240mm x H 140mm PACKING : 12PCS/CTN
- **N-110-06** 8426/8026 – SIZE : D 260mm x H 150mm PACKING : 6PCS/CTN
- **N-110-07** 8428/8028 – SIZE : D 280mm x H 160mm PACKING : 6PCS/CTN
- **N-110-08** 8430/8030 – SIZE : D 300mm x H 170mm PACKING : 6PCS/CTN
- **N-110-09** 8432/8032 – SIZE : D 320mm x H 180mm PACKING : 6PCS/CTN
- **N-110-10** 8434/8034 – SIZE : D 340mm x H 190mm PACKING : 6PCS/CTN
- **N-110-11** 8436/8036 – SIZE : D 360mm x H 200mm PACKING : 6PCS/CTN

S/STEEL STRAIGHT OIL POT



- **N-110-12** P11-22 100402 – SIZE : D220mm PACKING : 48PCS/CTN
- **N-110-13** P11-24 100403 – SIZE : D240mm PACKING : 48PCS/CTN
- **N-110-14** P11-26 100404 – SIZE : D260mm PACKING : 48PCS/CTN



S/STEEL PAN

SANDWICH BOTTOM S/STEEL FRYING PAN



- **N-112-01 2040S** – SIZE : **D200mm x H40mm** THICKNESS : **0.8mm** PACKING : **6PCS/CTN**
- **N-112-02 2241S** – SIZE : **D220mm x H41mm** THICKNESS : **0.8mm** PACKING : **6PCS/CTN**
- **N-112-03 2445S** – SIZE : **D240mm x H45mm** THICKNESS : **0.8mm** PACKING : **6PCS/CTN**
- **N-112-04 2647S** – SIZE : **D260mm x H47mm** THICKNESS : **0.8mm** PACKING : **6PCS/CTN**
- **N-112-05 2848S** – SIZE : **D280mm x H48mm** THICKNESS : **0.8mm** PACKING : **6PCS/CTN**
- **N-112-06 3049S** – SIZE : **D300mm x H49mm** THICKNESS : **0.8mm** PACKING : **6PCS/CTN**
- **N-112-07 3250S** – SIZE : **D320mm x H50mm** THICKNESS : **0.8mm** PACKING : **6PCS/CTN**

SANDWICH BOTTOM S/STEEL FRYING PAN WITH HELPER

HDL



- **N-112-08 3653S** – SIZE : **D360mm x H53mm** THICKNESS : **0.8mm** PACKING : **6PCS/CTN**
- **N-112-09 4055S** – SIZE : **D400mm x H55mm** THICKNESS : **0.8mm** PACKING : **6PCS/CTN**

SANDWICH BOTTOM S/STEEL DOUBLE HDL FRYING PAN



- N-113-01 3653S – SIZE : D360mm x H53mm THICKNESS : 0.8mm PACKING : 6PCS/CTN
- N-113-02 4055S – SIZE : D400mm x H55mm THICKNESS : 0.8mm PACKING : 6PCS/CTN

C0900 SERIES STAINLESS STEEL PAELLA PAN



- N-113-03 C0920 – SIZE : D 200mm PACKING : 40 PCS/CTN
- N-113-04 C0924 – SIZE : D 240mm PACKING : 40 PCS/CTN
- N-113-05 C0928 – SIZE : D 280mm PACKING : 40 PCS/CTN
- N-113-06 C0932 – SIZE : D 320mm PACKING : 30 PCS/CTN

JAPANESE FLAT PAN WOODEN HANDLE W/COVER



- N-113-07 XS-288 101925 – SIZE : D160mm PACKING : 60PCS/CTN

S/STEEL SNOW PAN



- **N-114-01 SNP18** – SIZE : **18cm** PACKING: **48 PCS/CTN**
- **N-114-02 SNP20** – SIZE : **20cm** PACKING: **48 PCS/CTN**
- **N-114-03 SNP22** – SIZE : **22cm** PACKING: **48 PCS/CTN**

S/STEEL WATER SCOOP (LONG HANDLE)



- **N-114-04 SWS18** – SIZE : **D 18 cm x H 8.2 cm**
TOTAL LENGTH : **32.8 cm**
- **N-114-05 SWS20** – SIZE : **D 20.1 cm x H 8.4 cm**
TOTAL LENGTH : **34.5 cm**

S/STEEL SAUCE PAN/ S/STEEL MILK PAN



- **N-114-06 8516 /8116** – SIZE : **D 160mm x H 83mm**
PACKING : **12PCS/CTN**
- **N-114-07 8518 /8118** – SIZE : **D 180mm x H 95mm**
PACKING : **12PCS/CTN**
- **N-114-08 8520 /8120** – SIZE : **D 200mm x H 110mm**
PACKING : **12PCS/CTN**
- **N-114-09 8522 /8122** – SIZE : **D 220mm x H 120mm**
PACKING : **12PCS/CTN**

SPAREPARTS SERIES

STEAMBOAT POT LID



- N-115-01 C9024 – SIZE : D 240mm
- N-115-02 C9026 – SIZE : D 260mm
- N-115-03 C9028 – SIZE : D 280mm
- N-115-04 C9030 – SIZE : D 300mm



* Knob available - C9001

STEAMBOAT POT LID WITH HANDLE

- N-115-05 C9126 – SIZE : D 260mm
- N-115-06 C9128 – SIZE : D 280mm
- N-115-07 C9130 – SIZE : D 300mm
- N-115-08 C9132 – SIZE : D 320mm

SAUCEPAN LID



- N-115-09 C9218 – SIZE : D 180mm
- N-115-10 C9220 – SIZE : D 200mm
- N-115-11 C9222 – SIZE : D 220mm



NON-STICK HONEYCOMB WOK & FRYING PAN

STAINLESS STEEL NON-STICK HONEYCOMB WOK WITH GLASS LID



O-117-01 NSHW32 – SIZE : 32cm



Honeycomb hexagon pans eliminate your main problems you face when cooking - even heat distribution for perfect cooking, and the burdensome task of scrubbing or soaking baked on messes after cooking. The secret is the patented elevated honeycomb stainless steel micro structure, combined with the lower ceramic non-stick surface. The result? A virtually indestructible non-stick surface with 100% even heat distribution.

You will love:

- Getting those restaurant quality pan sear marks on veggies and meats
- Easily cooking foods at the perfect temperature, without stress
- Using little to no oil or butter in your cooking
- Being able to use your metal spatula, knives, forks, whisks without scratching the non-stick surface
- Having commercial grade cookware in your home at an affordable price
- And the simplest, quickest clean up ever!



So how does it work? Well, we start with a clad constructed pan. That means there is an inner and outer layer of commercial restaurant grade stainless steel. These two layers then sandwich a middle third layer of aluminum. So the stainless steel provides superior non-stick properties and durability, while the aluminum core provides 100% even heat distribution in your pan. This is where you really start to get great cooking results.

STRUCTURAL FEATURES



Commercial Grade Construction : Stop buying department or discount store cookware. It simply does not last. By comparison, our honeycomb pan is T304 heavy-gauge stainless steel - the type most restaurants use. The amazing pan core is high grade aluminum, which eliminates hot spots in the pan. The handle is a chef quality double-riveted long handle, and features a beautiful brushed finish and forged kitchen hook.

While the non-stick and cooking attributes of this pan are superior to available cookware today, we must say the aesthetics make this pan one of the most attractive you bring into your kitchen. From the striking black ceramic and stainless hex surface, to the mirrored finish exterior, and the brushed satin exterior pan bottom, this pan elevates any kitchen.

Healthier Cooking : Using the honeycomb ceramic and stainless steel non-stick design actually creates much healthier cooking. There will be little to no need for using butter or oil in your cooking. With a true non-stick surface, you don't have to use unnecessary fats to keep food from sticking. For example, we've all buttered our pans before cooking eggs, fish, etc. But now you get perfectly seared and cooked food, but without the added calories.

Safe For Metal Utensils : Using honeycomb hex non-stick surface pans, you actually can use any type of metal utensil you want in the pan - metal spatulas, metal forks, knives, tongs, you name it. All without fear of scratching the ceramic surface due to the raised hex stainless steel protective barrier.

Use the Honeycomb Pan Everywhere : Imagine a pan that works perfectly on every type of cooking surface. The honeycomb pan works with electric stoves, gas stoves, induction cooktops, ovens, halogen cooktops, solid plate heating, barbecues, grills and even open campfires!

SANDWICH BOTTOM S/STEEL NON-STICK FRYING PAN



- **O-119-01 2040N** – SIZE : **D200mm x H40mm**
THICKNESS : **0.8mm** PACKING : **6PCS/CTN**
- **O-119-02 2241N** – SIZE : **D220mm x H41mm**
THICKNESS : **0.8mm** PACKING : **6PCS/CTN**
- **O-119-03 2445N** – SIZE : **D240mm x H45mm**
THICKNESS : **0.8mm** PACKING : **6PCS/CTN**
- **O-119-04 2647N** – SIZE : **D260mm x H47mm**
THICKNESS : **0.8mm** PACKING : **6PCS/CTN**
- **O-119-05 2848N** – SIZE : **D280mm x H48mm**
THICKNESS : **0.8mm** PACKING : **6PCS/CTN**
- **O-119-06 3049N** – SIZE : **D300mm x H49mm**
THICKNESS : **0.8mm** PACKING : **6PCS/CTN**
- **O-119-07 3250N** – SIZE : **D320mm x H50mm**
THICKNESS : **0.8mm** PACKING : **6PCS/CTN**

SQUARE ALUM.FRY.PAN



- **O-119-08 1518** –
SIZE : **L 18 cm x W 15 cm x H 3 cm**
THICKNESS : **3 mm**

SANDWICH BOTTOM S/STEEL NON-STICK FRYING PAN WITH HELPER HDL



- **O-119-09 3653N** – SIZE : **D360mm x H53mm**
THICKNESS : **0.8mm** PACKING : **6PCS/CTN**
- **O-119-10 4055N** – SIZE : **D400mm x H55mm**
THICKNESS : **0.8mm** PACKING : **6PCS/CTN**

SANDWICH BOTTOM S/STEEL DOUBLE HDL NON-STICK FRYING PAN



- **O-120-01 3653N** – SIZE : D360mm x H53mm THICKNESS : 0.8mm PACKING : 6PCS/CTN
- **O-120-02 4055N** – SIZE : D400mm x H55mm THICKNESS : 0.8mm PACKING : 6PCS/CTN

NON-STICK FRY PAN



- **O-120-03 EK-VP1623-MA (2.3MM)** – SIZE : Ø 16 cm x H 3.8 cm TOTAL LENGTH : L 31.5 cm
- **O-120-04 EK-VP1823-MA (2.3MM)** – SIZE : Ø 18 cm x H 4 cm TOTAL LENGTH : L 33.5 cm
- **O-120-05 EK-VP2023-MA (2.3MM)** – SIZE : Ø 20 cm x H 4.6 cm TOTAL LENGTH : L 35.5 cm
- **O-120-06 EK-VP2223-MA (2.3MM)** – SIZE : Ø 22 cm x H 4.6 cm TOTAL LENGTH : L 37.5 cm
- **O-120-07 EK-VP2423-MA (2.3MM)** – SIZE : Ø 24 cm x H 4.8 cm TOTAL LENGTH : L 42.7 cm
- **O-120-08 EK-VP2623-MA (2.3MM)** – SIZE : Ø 26 cm x H 5.4 cm TOTAL LENGTH : L 44.5 cm
- **O-120-09 EK-VP2823-MA (2.3MM)** – SIZE : Ø 28 cm x H 5.6 cm TOTAL LENGTH : L 46.5 cm
- **O-120-10 EK-VP3023-MA (2.3MM)** – SIZE : Ø 30 cm x H 5.9 cm TOTAL LENGTH : L 48.5 cm
- **O-120-11 EK-VP3223-MA (2.3MM)** – SIZE : Ø 32 cm x H 6 cm TOTAL LENGTH : L 50.5 cm

Aluminum has excellent heat conductivity and it's also lightweight and affordable. Non-stick surface allows food cooking with less fat and reduces risk of sticking and burning. The non-stick surface also prevents direct food contact to the aluminum which eliminate the worry of cooking acidic food may cause aluminum leaching. Whether you're frying, searing, or sauté the aluminum non-stick frying pan can handle all the heat in the kitchen.

Care and Use:

- Wash, rinse and dry before using it for the first time.
- Wash with soft side of sponge and mild detergent.
- Allow this product to cool down before washing and completely dry it before storing.
- Avoid liquid or powder detergent containing bleach or acidic substance.
- Hand washing recommended.
- For stubborn stains or burnt food, you can put some water and mild detergent on this product and boil it to loosen stubborn stains.
- Wooden utensils, silicone tools are recommended.

CAPATI PLATE (IRON)



- **O-121-01** TK-C-12 – SIZE : 12"
- **O-121-02** TK-C-14 – SIZE : 14"
- **O-121-03** TK-C-16 – SIZE : 16"

HOT PLATE



- **O-121-04** TK-HP-1115 – SIZE : 11" x 15"
- **O-121-05** TK-HP-1216 – SIZE : 12" x 16"
- **O-121-06** TK-HP-1418 – SIZE : 14" x 18"
- **O-121-07** TK-HP-1520 – SIZE : 15" x 20"
- **O-121-08** TK-HP-1624 – SIZE : 16" x 24"
- **O-121-09** TK-HP-1830 – SIZE : 18" x 30"

ALUMINIUM PRODUCT

DOUBLE HANDLE ALUMINIUM DEGCHI POT



- P-122-01 – SIZE : 50 cm
- P-122-02 – SIZE : 55 cm
- P-122-03 – SIZE : 60 cm
- P-122-04 – SIZE : 65 cm
- P-122-05 – SIZE : 70 cm
- P-122-06 – SIZE : 75 cm
- P-122-07 – SIZE : 80 cm
- P-122-08 – SIZE : 85 cm

ALUMINIUM DEGCHI POT



- P-122-09 – SIZE : 16 cm
- P-122-10 – SIZE : 17 cm
- P-122-11 – SIZE : 18 cm
- P-122-12 – SIZE : 20 cm
- P-122-13 – SIZE : 22 cm
- P-122-14 – SIZE : 24 cm
- P-122-15 – SIZE : 26 cm
- P-122-16 – SIZE : 28 cm
- P-122-17 – SIZE : 30 cm
- P-122-18 – SIZE : 32 cm
- P-122-19 – SIZE : 34 cm
- P-122-20 – SIZE : 36 cm
- P-122-21 – SIZE : 38 cm
- P-122-22 – SIZE : 40 cm
- P-122-23 – SIZE : 42 cm
- P-122-24 – SIZE : 46 cm
- P-122-25 – SIZE : 48 cm
- P-122-26 – SIZE : 50 cm
- P-122-27 – SIZE : 55 cm
- P-122-28 – SIZE : 60 cm
- P-122-29 – SIZE : 65 cm

SARAWAK POT



- **P-123-01** A1201 – SIZE : 16cm
PACKING : 5PCS/CTN
- **P-123-02** A1202 – SIZE : 18cm
PACKING : 5PCS/CTN
- **P-123-03** A1203 – SIZE : 20cm
PACKING : 5PCS/CTN
- **P-123-04** A1204 – SIZE : 22cm
PACKING : 5PCS/CTN
- **P-123-05** A1205 – SIZE: 26cm
PACKING : 5PCS/CTN
- **P-123-06** A1206 – SIZE : 28cm
PACKING : 5PCS/CTN
- **P-123-07** A1207 – SIZE : 30cm
PACKING : 5PCS/CTN
- **P-123-08** A1208 – SIZE : 33cm
PACKING : 5PCS/CTN

KETTLE



- **P-123-09** A0110 – SIZE : 492mm x 323mm x 340mm
Capacity : 1.7 LITRE
PACKING : 1 DOZ
- **P-123-10** A0120 – SIZE : 561mm x 350mm x 387mm
Capacity : 2.2 LITRE
PACKING : 1 DOZ
- **P-123-11** A0130 – SIZE : 613mm x 365mm x 425mm
Capacity : 3.5 LITRE
PACKING : 1 DOZ
- **P-123-12** A0140 – SIZE : 664mm x 424mm x 455mm
Capacity : 4.5 LITRE
PACKING : 1 DOZ
- **P-123-13** A0150 – SIZE : 736mm x 464mm x 495mm
Capacity : 5.5 LITRE
PACKING : 1 DOZ
- **P-123-14** A0160 – SIZE : 794mm x 494mm x 540mm
Capacity : 7 LITRE
PACKING : 1 DOZ



P-124-01 ALU KETTLE (CANDY)
THAILAND



P-124-02 Z CODE 24PCS
ALUMINIUM TAPE



- **P-124-03** HL-001 NO.1
ALUMINIUM LADLE
- **P-124-04** HL-002 NO.2
ALUMINIUM LADLE



- **P-124-05** ALUMINIUM LAZY
SUSAN – SIZE : D 40 cm
- **P-124-06** ALUMINIUM LAZY
SUSAN – SIZE : D 45 cm



P-124-07 9044 SENDUK 5 KATI
PANJANG

3 LAYER ALUMINIUM PRESSURE COOKER



- **P-124-08** A300 – SIZE : 30cm
- **P-124-09** A320 – SIZE : 32cm
- **P-124-10** A340 – SIZE : 34cm
- **P-124-11** A360 – SIZE : 36cm
- **P-124-12** A400 – SIZE: 40cm
- **P-124-13** A440 – SIZE : 44cm

FRY PAN ALUMINUM



- **P-125-01** HL-A-FW-12 – SIZE : 12" PACKING: 5 CTN
- **P-125-02** HL-A-FW-13 – SIZE : 13" PACKING: 10 CTN
- **P-125-03** HL-A-FW-14 – SIZE : 14" PACKING: 10 CTN
- **P-125-04** HL-A-FW-15 – SIZE : 15" PACKING: 10 CTN
- **P-125-05** HL-A-FW-16 – SIZE : 16" PACKING: 10 CTN
- **P-125-06** HL-A-FW-17 – SIZE : 17" PACKING: 10 CTN
- **P-125-07** HL-A-FW-18 – SIZE : 18" PACKING: 5 CTN

ALUMINIUM WOK



- **P-125-08** WK-LY-B-08 – SIZE : 8" PACKING : 50PCS/CTN
- **P-125-09** WK-LY-B-09 – SIZE : 9" PACKING : 50PCS/CTN
- **P-125-10** WK-LY-B-10 – SIZE : 10" PACKING : 50PCS/CTN
- **P-125-11** WK-LY-B-11 – SIZE : 11" PACKING : 50PCS/CTN
- **P-125-12** WK-LY-B-12 – SIZE : 12" PACKING : 50PCS/CTN
- **P-125-13** WK-LY-B-13 – SIZE : 13" PACKING : 50PCS/CTN
- **P-125-14** WK-LY-B-14 – SIZE : 14" PACKING : 40PCS/CTN
- **P-125-15** WK-LY-B-15 – SIZE : 15" PACKING : 40PCS/CTN
- **P-125-16** WK-LY-B-16 – SIZE : 16" PACKING : 30PCS/CTN
- **P-125-17** WK-LY-B-17 – SIZE : 17" PACKING : 30PCS/CTN
- **P-125-18** WK-LY-B-18 – SIZE : 18" PACKING : 20PCS/CTN
- **P-125-19** WK-LY-B-19 – SIZE : 19" PACKING : 20PCS/CTN
- **P-125-20** WK-LY-B-20 – SIZE : 20" PACKING : 15PCS/CTN
- **P-125-21** WK-LY-B-21 – SIZE : 21" PACKING : 15PCS/CTN
- **P-125-22** WK-LY-B-22 – SIZE : 22" PACKING : 10PCS/CTN
- **P-125-23** WK-LY-B-24 – SIZE : 24" PACKING : 10PCS/CTN
- **P-125-24** WK-LY-B-27 – SIZE : 27" PACKING : 5PCS/CTN
- **P-125-25** WK-LY-B-30 – SIZE : 30" PACKING : 5PCS/CTN





CARBON STEEL DEEP SHANGHAI WOK



- P-127-01 CS14 – SIZE : 14"
- P-127-02 CS15 – SIZE : 15"
- P-127-03 CS16 – SIZE : 16"
- P-127-04 CS17 – SIZE : 17"
- P-127-05 CS18 – SIZE : 18"

DOUBLE HANDLE DEEP CARBON STEEL SHANGHAI WOK



- P-127-06 DHCS15 – SIZE : 15"
- P-127-07 DHCS16 – SIZE : 16"
- P-127-08 DHCS17 – SIZE : 17"
- P-127-09 DHCS18 – SIZE : 18"
- P-127-10 DHCS20 – SIZE : 20"
- P-127-11 DHCS22 – SIZE : 22"
- P-127-12 DHCS24 – SIZE : 24"
- P-127-13 DHCS26 – SIZE : 26"
- P-127-14 DHCS28 – SIZE : 28"
- P-127-15 DHCS30 – SIZE : 30"
- P-127-16 DHCS32 – SIZE : 32"

CLAY POT



SINGLE HANDLE CLAY POT

- P-128-01 S1 – SIZE : 10" (25.5cm) Capacity : 1400ml
- P-128-02 S2 – SIZE : 9.25" (23.5cm) Capacity : 1300ml
- P-128-03 S3 – SIZE : 8.5" (21.5cm) Capacity : 1000ml
- P-128-04 S4 – SIZE : 8" (19cm) Capacity : 850ml
- P-128-05 S5 – SIZE : 6.75" (17cm) Capacity : 500ml

SALT POT



- P-128-11 CS -3 – SIZE : S
- P-128-12 CS - 4 – SIZE : M
- P-128-13 CS - 5 – SIZE : L
- P-128-14 CS - 6 – SIZE : XL

DOUBLE HANDLE CLAY



- P-128-06 D3 – SIZE : 7" (18cm) Capacity : 590ml
- P-128-07 D4 – SIZE : 7.5" (19cm) Capacity : 800ml
- P-128-08 D5 – SIZE : 8.75" (22cm) Capacity : 1000ml
- P-128-09 D6 – SIZE : 9" (23cm) Capacity : 1200ml
- P-128-10 D7 – SIZE : 9.5" (24cm) Capacity : 1350ml



CHARCOAL STOVE / RED STOVE CHINESE TRADITIONAL CHARCOAL CLAY



- P-129-01 – SIZE : 8"
- P-129-02 – SIZE : 11"
- P-129-03 – SIZE : 12"

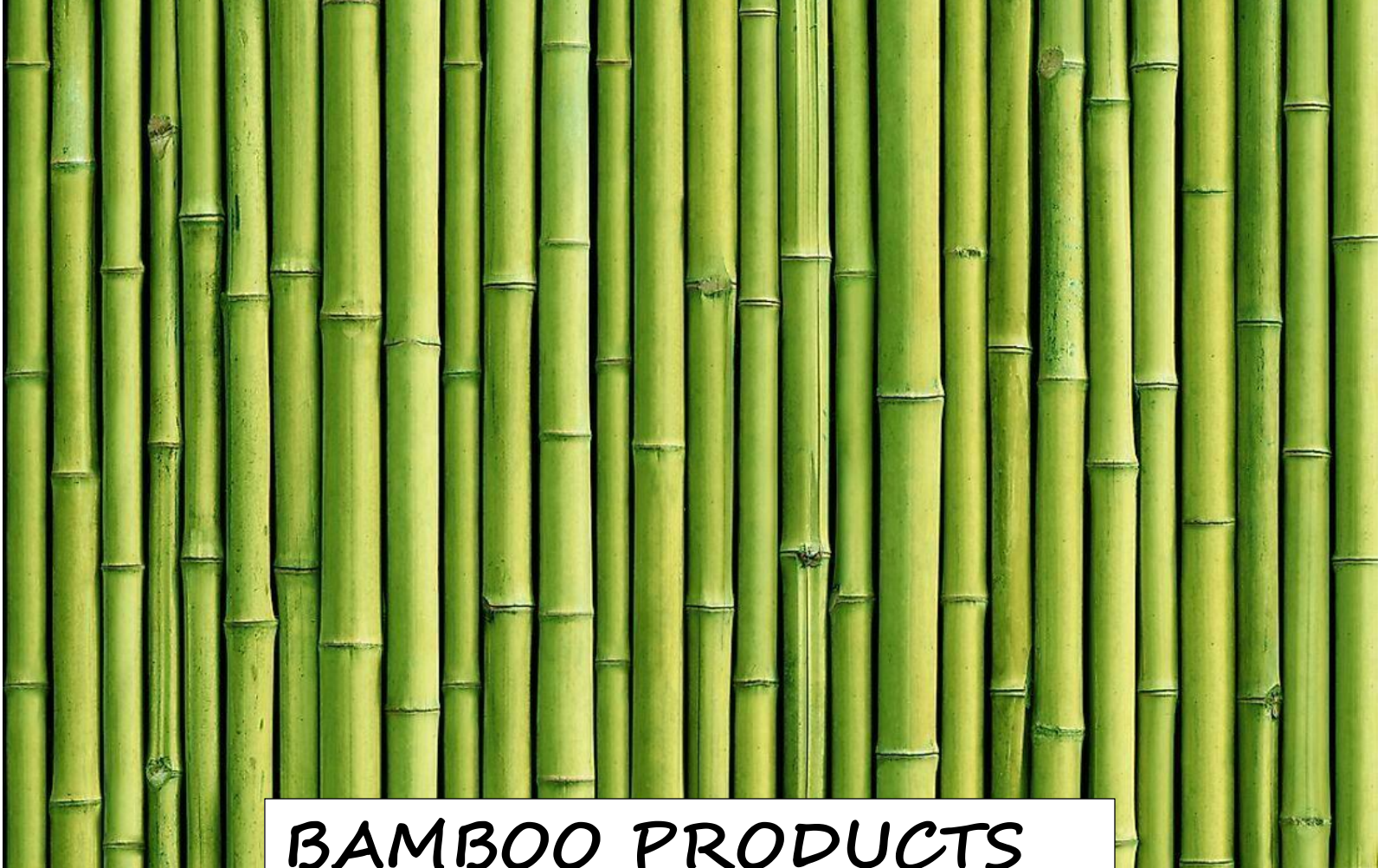

BAMBOO PRODUCTS





Q-131-01 - WOK BRUSH



**Q-131-02 WB300 BAMBOO WOK BRUSH –
PACKING :100PCS/CTN**

A wok brush is a type of kitchenware that is used to clean a wok. It is made of a bundle of split bamboo stalks tied at the top. It is used with the wok still hot and with hot water or water added to a heated wok to clean without degreaser so the wok does not rust.

To maintain the layer built up on the surface of the wok over time, the bamboo filaments must be strong enough to eliminate any remains stuck to the wok itself, and at the same time, soft enough that no damage is made to the surface of the wok.

3 X BAMBOO FRUIT BASKET



- Q-131-03 – SIZE : 22cm (8.5")
- Q-131-04 – SIZE : 26cm (10")
- Q-131-05 – SIZE : 30cm (12")

3 X JAP ROUND SMALL BAMBOO MESH



- Q-131-06 – SIZE : 26cm (10")
- Q-131-07 – SIZE : 30cm (12")
- Q-131-08 – SIZE : 35cm (14")



12 HOLES BAMBOO DRAINER



Q-132-01 BD-12 101292 –
PACKING : 1000PCS/CTN

SUSHI MAT



- **Q-132-02** SM-2324 101241 – SIZE : 230mm x 240mm
PACKING : 150PCS/CTN
- **Q-132-03** SM-2727 101240 – SIZE : 270mm x 270mm
PACKING : 200PCS/CTN

ROUND SHAPE BAMBOO BASKET



- **Q-132-04** – SIZE : 5"
- **Q-132-05** – SIZE : 6"
- **Q-132-06** – SIZE : 7"
- **Q-132-07** – SIZE : 8"
- **Q-132-08** – SIZE : 9"
- **Q-132-09** – SIZE : 10"

OVAL SHAPE BAMBOO BASKET



- **Q-132-10** – SIZE : 6"
- **Q-132-11** – SIZE : 7"
- **Q-132-12** – SIZE : 8"
- **Q-132-13** – SIZE : 9"

Made from woven bamboo - our high quality bread basket will add a traditional accompaniment to your table providing a simple way of offering your guests bread rolls - sauce sachets and much more.

BAMBOO STEAMER WITH ALUMINIUM FRAME & LID



BAMBOO STEAMER WITH ALUMINIUM FRAME

- Q-133-01 5" – PACKING : 300 PCS/CTN
- Q-133-02 6" – PACKING : 100 PCS/CTN
- Q-133-03 7" – PACKING : 100 PCS/CTN
- Q-133-04 8" – PACKING : 60 PCS/CTN
- Q-133-05 10" – PACKING : 40 PCS/CTN
- Q-133-06 12" – PACKING : 40 PCS/CTN
- Q-133-07 14" – PACKING : 20 PCS/CTN
- Q-133-08 16" – PACKING : 10 PCS/CTN
- Q-133-09 18" – PACKING : 10 PCS/CTN
- Q-133-10 20.5" – PACKING : 5 PCS/CTN

LID

- Q-133-11 5" – PACKING : 300 PCS/CTN
- Q-133-12 6" – PACKING : 200 PCS/CTN
- Q-133-13 7" – PACKING : 200 PCS/CTN
- Q-133-14 8" – PACKING : 120 PCS/CTN
- Q-133-15 10" – PACKING : 60 PCS/CTN
- Q-133-16 12" – PACKING : 80 PCS/CTN
- Q-133-17 14" – PACKING : 34 PCS/CTN
- Q-133-18 16" – PACKING : 30 PCS/CTN
- Q-133-19 18" – PACKING : 30 PCS/CTN
- Q-133-20 20.5" – PACKING : 10 PCS/CTN



BAMBOO STEAMER WITH RUBBER FRAME & LID



BAMBOO STEAMER WITH RUBBER FRAME

- Q-134-01 PS5" – PACKING : 300 PCS/CTN
- Q-134-02 PS6" – PACKING : 100 PCS/CTN
- Q-134-03 PS7" – PACKING : 100 PCS/CTN
- Q-134-04 PS8" – PACKING : 60 PCS/CTN

LID

- Q-134-05 PC5" – PACKING : 300 PCS/CTN
- Q-134-06 PC6" – PACKING : 400 PCS/CTN
- Q-134-07 PC7" – PACKING : 200 PCS/CTN
- Q-134-08 PC8" – PACKING : 120 PCS/CTN



Natural material

Selected deep-mountain old bamboo, delicately made, to maintain the delicacy of the original juice of food.

Compilation process

Hand-made
Steaming Cage



MULTI-PURPOSE COTTON STEAMER CLOTH



Q-135-01 BJ-2596 – SIZE : L 65 cm x W 86 cm

MULTI-PURPOSE COOKING BAG



- Q-135-02 BJ-2688(S) (1X4PCS) – SIZE : L 22 cm x W 16 cm
- Q-135-03 BJ-2633(M) (1X3PCS) – SIZE : L 28 cm x W 21 cm
- Q-135-04 BJ-2640(L) (1X2PCS) – SIZE : L 35CM x W 27CM

COTTON SOYA MILK BAG



Q-136-01 BJ-2534 – SIZE : L 45 cm x W 33 cm



NON-STICK RICE COOKER MAT



Q-136-02 621730 –
SIZE : L 111 cm x W 112 cm



Goodfood

weekend special



CUTLERY SERIES



R-138-01 SS11 S/STEEL
SQUARE SERVING SPOON –
SIZE : 10”
PACKING : 300 PCS/CTN



R-138-02 SF482 S/STEEL
SERVING FORK –
SIZE : 10.5”
PACKING : 300 PCS/CTN



R-138-03 SS471-2# S/STEEL
SQUARE SERVING SPOON–
SIZE : 8.5”
PACKING : 300 PCS/CTN



R-138-04 SVS525-1# 1# S/STEEL
SERVING SPOON –
SIZE : 8.5”
PACKING : 300 PCS/CTN



R-138-05 SF481 S/STEEL
SERVING FORK –
SIZE : 8.5”
PACKING : 300 PCS/CTN



R-138-06 SVS523-2# 2#
S/STEEL SERVING SPOON –
SIZE : 7.5”
PACKING : 300 PCS/CTN



R-138-07 TBS011 S/STEEL TABLE
SPOON –
SIZE : 8.5”
PACKING : 300 PCS/CTN



R-138-08 TBF031 S/STEEL
TABLE FORK –
SIZE : 8.5”
PACKING : 300 PCS/CTN



R-138-09 TBK291
S/STEEL TABLE KNIFE –
SIZE : 9”
PACKING : 300 PCS/CTN



R-138-10 SPS021-1# S/STEEL
SOUP SPOON–
SIZE : 8”
PACKING : 300 PCS/CTN



R-138-11 DSS131 S/STEEL
DESSERT SPOON–
SIZE : 7.5”
PACKING : 300 PCS/CTN



R-138-12 DSF151
S/STEEL DESSERT FORK –
SIZE : 7.5”
PACKING : 300 PCS/CTN



R-138-13 DSK281 S/STEEL
DESSERT KNIFE –
SIZE : 8”
PACKING : 300 PCS/CTN



R-138-14 SS31 S/STEEL
SALAD FORK @ SPOON –
SIZE : 7.5”
PACKING : 300 PCS/CTN



R-138-15 IES36 S/STEEL
ICE CREAM SPOON –
SIZE : 5”
PACKING : 600 PCS/CTN



R-139-01 SPS141-2# S/STEEL
SOUP SPOON –
SIZE : 7”
PACKING : 300 PCS/CTN



R-139-02 BTK371
S/STEEL BUTTER KNIFE –
SIZE : 6.5”
PACKING : 600 PCS/CTN



R-139-03 LDS251 S/STEEL
LONG DRINK SPOON –
SIZE : 7”
PACKING : 300 PCS/CTN



R-139-04 CKS49 S/STEEL CAKE
SERVER –
SIZE : 9”
PACKING : 300 PCS/CTN



R-139-05 SK30 S/STEEL STEAK
KNIFE –
SIZE : 8.5”
PACKING : 300 PCS/CTN



R-139-06 TAS221 S/STEEL TEA
SPOON –
SIZE : 5.5”
PACKING : 600 PCS/CTN



R-139-07 SAP31 S/STEEL
SALAD SPOON – SIZE : 7.5”
PACKING : 300 PCS/CTN



R-139-08 CKF241 S/STEEL
CAKE FORK –
SIZE : 5.5”
PACKING : 600 PCS/CTN



R-139-09 VF211 S/STEEL
VEGETABLE FORK – SIZE : 6.5”
PACKING : 300 PCS/CTN



R-139-10 SCS33 S/STEEL
COFFEE SPOON – SIZE : 4.5”
PACKING : 600 PCS/CTN



R-139-11 SGS231 S/STEEL SUGAR
SPOON – SIZE : 5”
PACKING : 600 PCS/CTN



R-139-12 SGS34 S/STEEL
SUGAR SPOON – SIZE : 4.5”
PACKING : 600 PCS/CTN



R-139-13 SF38 S/STEEL
OYSTER FORK – SIZE : 7”
PACKING : 300 PCS/CTN



R-139-14 SF35 S/STEEL FRUIT
FORK – SIZE : 4.5”
PACKING : 600 PCS/CTN



R-139-15 SS-838-SV
838 SERVING SPOON



R-139-16 CF115 CARVING FORK – SIZE : L 11.5”

A helpful companion in carving large meats. It features traditional, triple riveted, and ergonomic long handle design that assures high safety while carving.



L6-52B S/STEEL
PERFORATED SOUP LADLE –
SIZE : 60mm
PACKING : 300 PCS/CTN



L7-54B S/STEEL
PERFORATED SOUP LADLE –
SIZE : 70mm
PACKING : 300 PCS/CTN



V56B-8F S/STEEL
PERFORATED SOUP LADLE –
SIZE : 80mm
PACKING : 300 PCS/CTN



L7-53B S/STEEL SOUP LADLE –
SIZE : 70mm
PACKING : 300 PCS/CTN



V55B-8 S/STEEL SOUP LADLE –
SIZE : 80mm
PACKING : 300 PCS/CTN



L6-51B S/STEEL SOUP LADLE –
SIZE : 60mm
PACKING : 300 PCS/CTN



CHICKEN BOWL SERIES



R-142-01 SV007 –
 SIZE : 18.5cm x H 6.5cm
 PACKING : 50 PCS/CTN



R-142-02 SV008 –
 SIZE : 16.5cm x H 6cm
 PACKING : 80 PCS/CTN



R-142-03 SV009 –
 SIZE : 14.5cm x H 5.5cm
 PACKING : 120 PCS/CTN



R-142-04 SV010 –
 SIZE : 12.5cm x H 4.5cm
 PACKING : 160 PCS/CTN



JIN RONG BOWL (CHICKEN)



- **R-142-05 SU115 5" –**
 SIZE : W 125mm x H 58mm x B 65mm
 WEIGHT: 270G
 PACKING : 96PCS/CTN
- **R-142-06 SU116 6" –**
 SIZE : W 150mm x H 72mm x B 80mm
 WEIGHT: 420G
 PACKING : 48PCS/CTN
- **R-142-07 SU117 7" –**
 SIZE : W 177mm x H 80mm x B 90mm
 WEIGHT: 578G
 PACKING : 36PCS/CTN
- **R-142-08 SU118 8" –**
 SIZE : W 200mm x H 95mm x B 110mm
 WEIGHT: 800G
 PACKING : 24PCS/CTN

ROASTER CHICKEN SHALLOW PLATE

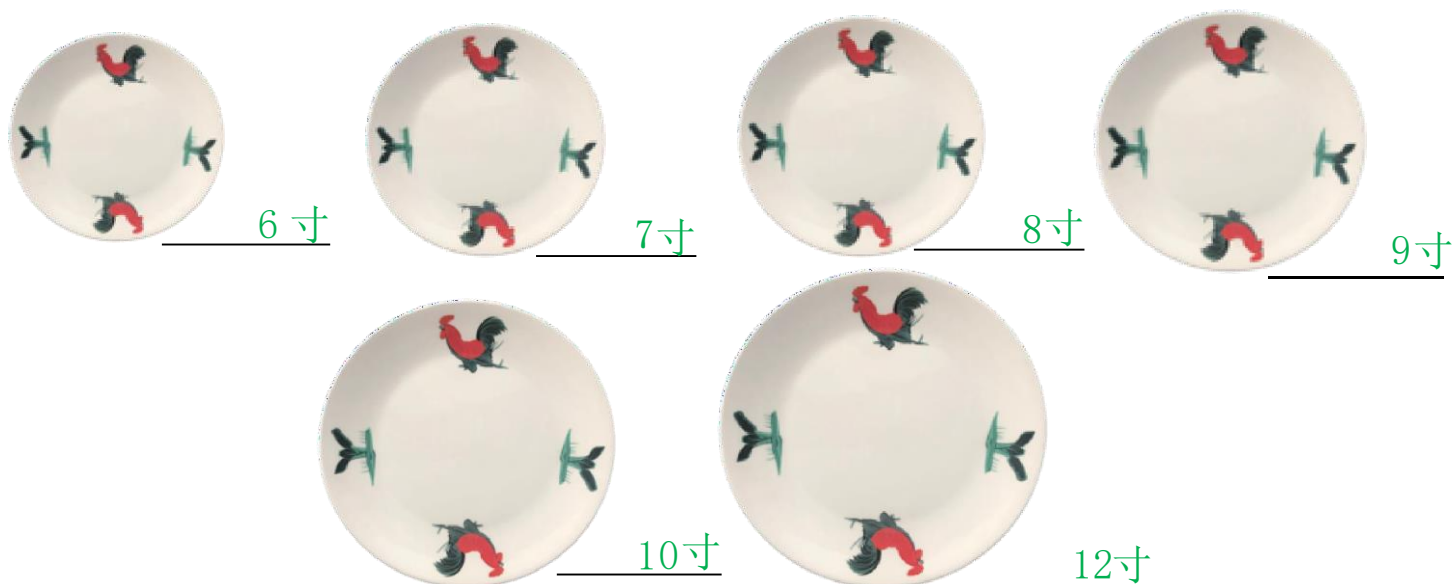

- R-143-01 SU127 6" – PACKING : 100 PCS/CTN
- R-143-02 SU128 7" – PACKING : 80 PCS/CTN
- R-143-03 SU129 8" – PACKING : 60 PCS/CTN
- R-143-04 SU130 9" – PACKING : 40 PCS/CTN
- R-143-05 SU131 10" – PACKING : 40 PCS/CTN
- R-143-06 SU132 12" – PACKING : 20 PCS/CTN

ROASTER CHICKEN RICE PLATE

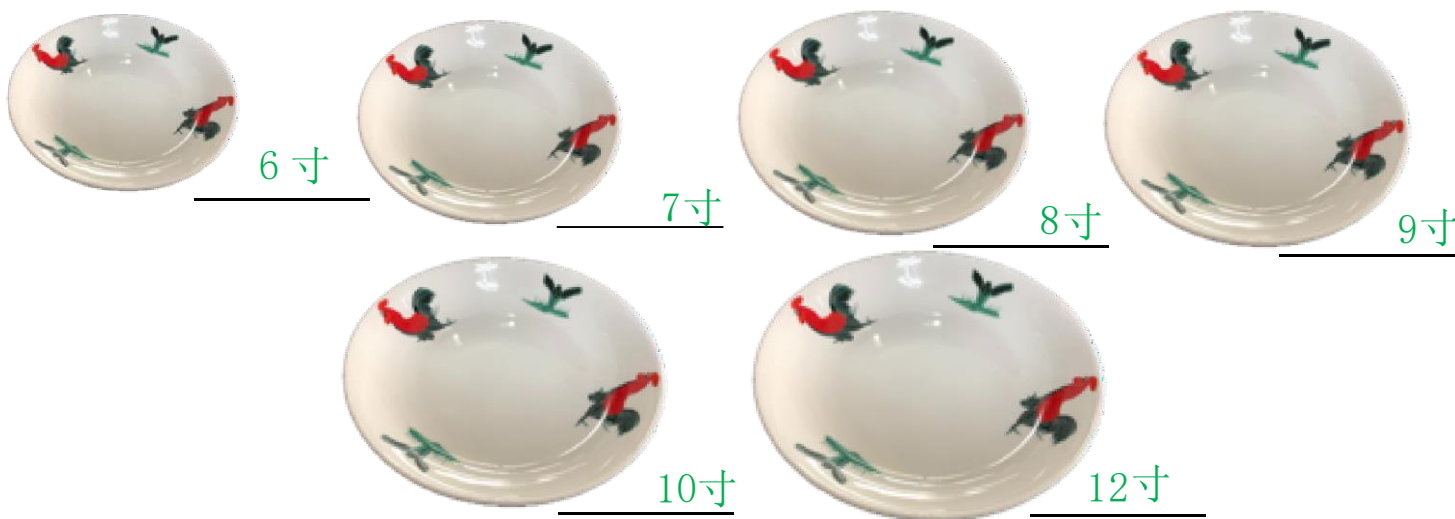

- R-143-07 SU135 6" – PACKING : 100 PCS/CTN
- R-143-08 SU122 7" – PACKING : 70 PCS/CTN
- R-143-09 SU105 8" – PACKING : 60 PCS/CTN
- R-143-10 SU106 9" – PACKING : 40 PCS/CTN
- R-143-11 SU107 10" – PACKING : 36 PCS/CTN
- R-143-12 SU136 12" – PACKING : 20 PCS/CTN

ROASTER CHICKEN FLAT PLATE

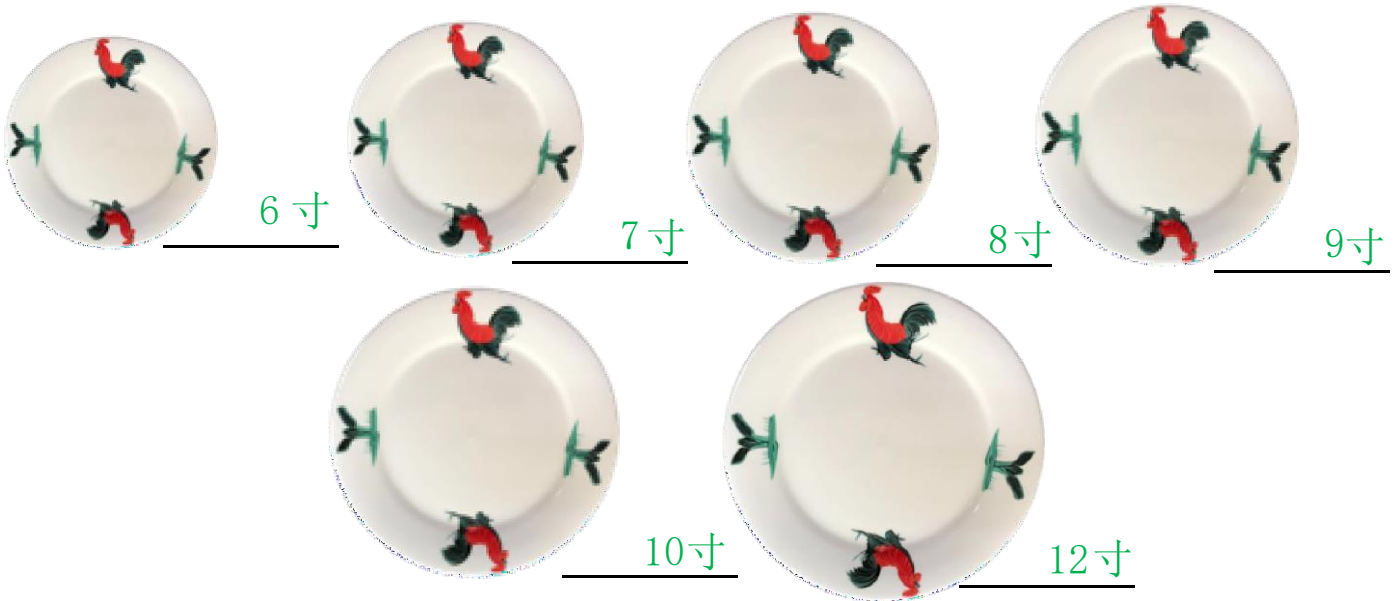

- R-144-01 SU110 6" – PACKING : 100 PCS/CTN
- R-144-02 SU133 7" – PACKING : 70 PCS/CTN
- R-144-03 SU111 8" – PACKING : 60 PCS/CTN
- R-144-04 SU134 9" – PACKING : 40 PCS/CTN
- R-144-05 SU108 10" – PACKING : 40 PCS/CTN
- R-144-06 SU109 12" – PACKING : 20 PCS/CTN

ROASTER CHICKEN RICE BOWL



4寸



4.5寸



5寸



6寸



7寸



8寸



9寸

- R-145-01 SU121 4" – PACKING : 120 PCS/CTN
- R-145-02 SU100 4.5" – PACKING : 120 PCS/CTN
- R-145-03 SU101 5" – PACKING : 80 PCS/CTN
- R-145-04 SU102 6" – PACKING : 48 PCS/CTN
- R-145-05 SU103 7" – PACKING : 36 PCS/CTN
- R-145-06 SU104 8" – PACKING : 30 PCS/CTN
- R-145-07 SU057 9" – PACKING : 24 PCS/CTN

ROASTER CHICKEN OVAL PLATE



8寸



9寸



10寸



12寸



14寸



16寸



18寸

- R-146-01 SU044 8" – PACKING : 60 PCS/CTN
- R-146-02 SU045 9" – PACKING : 60 PCS/CTN
- R-146-03 SU046 10" – PACKING : 50 PCS/CTN
- R-146-04 SU040 12" – PACKING : 30 PCS/CTN
- R-146-05 SU041 14" – PACKING : 20 PCS/CTN
- R-146-06 SU042 16" – PACKING : 15 PCS/CTN
- R-146-07 SU043 18" – PACKING : 10 PCS/CTN

CHICKEN TEA CUP & CHICKEN TEA POT



R-147-01 SU114 CHICKEN
TEA CUP –
SIZE : L 70mm x W 70mm x
H 55mm
PACKING : 100 PCS/CTN



R-147-02 SU058 CHICKEN
TEA CUP –
SIZE : L 70mm x W 65mm x
H 70mm
PACKING : 70 PCS/CTN



R-147-03 SU059 CHICKEN
TEA CUP –
SIZE : L 70mm x W 70mm x
H 70mm
PACKING : 60 PCS/CTN



R-147-04 SU031 5-GO CHICKEN
TEA POT –
PACKING : 30 PCS/CTN



R-147-05 SU051 2# CHICKEN
TEA POT –
PACKING : 40 PCS/CTN



R-147-06 SU018 60-GO CHICKEN
TEA POT –
PACKING : 24 PCS/CTN



R-147-07 SU019 80-GO CHICKEN
TEA POT –
PACKING : 12 PCS/CTN



R-147-08 SU020 90-GO CHICKEN
TEA POT –
PACKING : 12 PCS/CTN



R-147-09 SU026 100-GO CHICKEN
TEA POT –
PACKING : 8 PCS/CTN



4.5寸

R-148-01 SU056 4.5" ROASTER CHICKEN SHARKFIN BOWL –
SIZE : W 110mm x H 40mm
PACKING : 120PCS/CTN



R-148-02 SU113 XL PORCELAIN CHICKEN SOUP SPOON –
SIZE : L 130mm x H 40mm
PACKING : 800PCS/CTN



3.5寸

R-148-03 SU035 ROASTER CHICKEN ASH TRAY -
PACKING : 120PCS/CTN

ROASTER CHICKEN SALAD BOWL



6寸



7寸



8寸



9寸

- R-148-04 SU123 6" – PACKING : 80 PCS/CTN
- R-148-05 SU124 7" – PACKING : 60 PCS/CTN
- R-148-06 SU125 8" – PACKING : 50 PCS/CTN
- R-148-07 SU126 9" – PACKING : 30 PCS/CTN

ROASTER CHICKEN SOUP BOWL



8寸



9寸



10寸



11寸

- R-148-08 SU055 8" – PACKING : 60 PCS/CTN
- R-148-09 SU036 9" – PACKING : 60 PCS/CTN
- R-148-10 SU037 10" – PACKING : 50 PCS/CTN
- R-148-11 SU038 11" – PACKING : 30 PCS/CTN

ROASTER CHICKEN SEASONING DISH

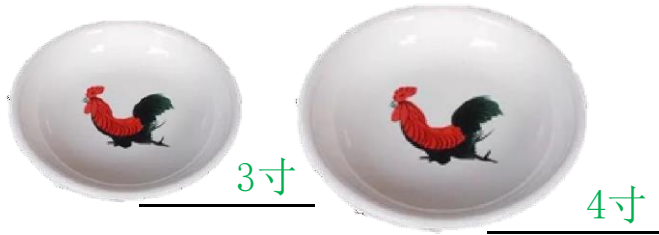

- R-149-01 SU120 3" – PACKING : 600 PCS/CTN
- R-149-02 SU119 4" – PACKING : 300 PCS/CTN

ROASTER CHICKEN SALAD PLATE

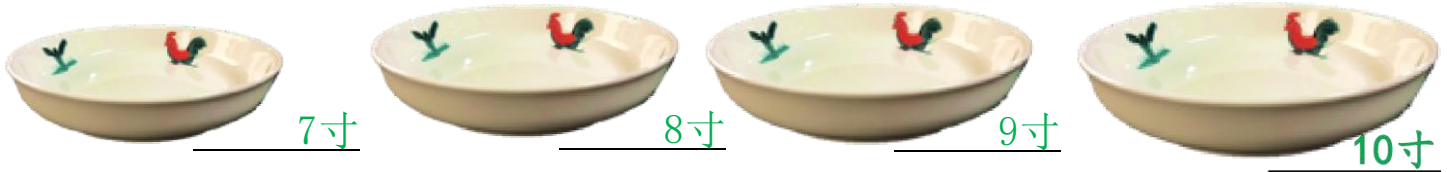

- R-149-03 SU047 7" – PACKING : 72 PCS/CTN
- R-149-04 SU048 8" – PACKING : 60 PCS/CTN
- R-149-05 SU049 9" – PACKING : 48 PCS/CTN
- R-149-06 SU050 10" – PACKING : 36 PCS/CTN

ROASTER CHICKEN RECTANGLE PLATE



- R-149-07 SU052 8" – SIZE : L 180mm x W 115mm PACKING : 60 PCS/CTN
- R-149-08 SU053 9" – SIZE : L 210mm x W 130mm PACKING : 60 PCS/CTN
- R-149-09 SU054 10" – SIZE : L 235mm x W 150mm PACKING : 48 PCS/CTN



KNIFE

PARING KNIFE & BONING KNIFE



- **S-151-01** 12122-6BK 2.5" STAINLESS STEEL CURVED PARING KNIFE – SIZE : L 2.5"
- **S-151-02** 12133-8BK 3" STAINLESS STEEL PARING KNIFE – SIZE : L 3"
- **S-151-03** 12144-10BK 4" STAINLESS STEEL PARING KNIFE – SIZE : L 4"
- **S-151-04** 12166-15BK 6" BONING KNIFE PROFLEX HANDLE – SIZE : L 6"

Stainless Steel Paring Knife is incredibly well made for every chef's precision cutting tasks in the kitchen. With this lightweight and small sized knife on hand, you will get impressed with how excel it works in dealing with the deveining, slicing, and garnishing tasks! Let's impress your guests by turning your fresh fruits and vegetables cuts into nutritious dishes that are aesthetically pleasing with our paring knife!

Durable Material:

Crafted from 5Cr15MoV, a premium stainless-steel material that prolong sharpness and edge retention.

High Versatility:

Designed to be multipurpose tool, our lightweight paring knife makes precision tasks such as deveining the prawns, peeling thick skin or garnishing a breeze!

Ergonomic Handle:

The ergonomically shaped polypropylene handle features non-slip texture which provides comfortable grip.

CHEF KNIFE PROFLEX HANDLE



- **S-152-01** 12188-15BK 6" – SIZE : L 6"
- **S-152-02** 12188-18BK 7" – SIZE : L 7"
- **S-152-03** 12188-20BK 8" – SIZE : L 8"
- **S-152-04** 12188-23BK 9" – SIZE : L 9"
- **S-152-05** 12188-25BK 10" – SIZE : L 10"
- **S-152-06** 12188-28BK 11" – SIZE : L 11"
- **S-152-07** 12188-30BK 12" – SIZE : L 12"

Behind the scene of preparation of every delicious meal, no matter how simple the dish is, 12188 Chef Knife Proflex Handle Classic Series should not be missing from your kitchen. With its high quality stainless steel blades that assures excellent cutting performance, you will be surprised with how versatile it can be in everyday food preparation tasks! Comprised of a rich variety of colors that not only brighten up your lovely kitchen and cooking mood, but also performs greatly in preventing cross-contamination of foods.

- An exceptional choice for professional and home chefs with high hygiene standards.
- Crafted from 5Cr15MoV, a premium stainless steel material that prolong sharpness and edge retention.
- Ergonomically shaped polypropylene handle for secure and comfortable grip.
- Perfect tool for cutting, dicing, mincing or slicing.



Care & Use:

- Wash, rinse and dry the knife before using it for the first time.
- Avoid cutting on hard surface such as stone, glass or metal.
- Hand-wash with the soft side of sponge & mild detergent; rinse & dry immediately after washed.
- Avoid from using liquid or powder detergent containing bleach or highly acidic substance.
- Use knife sharpener or sharpening stone to sharpen the knife.
- Store the knife in a safe place such as knife block or on a magnetic strip on the wall to protect its edge & prevent injury.

Warning:

- Keep out of reach of children.
- Wash & dry carefully, keeping sharp edge away from your hands.
- Don't attempt to catch a knife when it is falling – better it hits the floor than cut your hand.



JAPANESE KNIVES



S-153-01 51028 2.5MM DEBA KNIFE –

SIZE : L 16.5 cm

THICKNESS : 2.5 mm

Deba Knife is the Japanese version of filleting knife. It can be same size as Santoku Knife, but it's more curved. They are perfect for fillet fish or removing meat from bone. The heft of the knife allows it to cut through the head and bones of a fish, and the smaller pointed tip fillet the flesh from the bones. The Deba Knife can be used for chicken and meat as well but not recommended for cutting through large bones.

Care & Use:

- Wash, rinse and dry the knife before using it for the first time.
- Hand-wash with the soft side of sponge & mild detergent; rinse & dry with a soft cloth.
- Avoid from using liquid or powder detergent containing bleach or highly acidic substance.
- Sharpen with stone sharpener to maintain the sharpness.
- Do not attempt to cut, hit or chop frozen products or bones. It can cause the blade chip or break.



S-153-02 51030 1.5MM NAKIRI KNIFE–

SIZE : L 17 cm

THICKNESS : 1.5 mm

Nakiri is namely a traditional Japanese vegetable knife. It has unique and single single-sided blade design. It also one of the best tools to slice and chop for difficult cut veggie such as daikon and butternut squash. The deep and flat blade make them perfectly shredding large veggie like cabbage or lettuce. Keenly sharp edge can cut very thin slices, its prefect if you like to add ribbons of vegetable as a garnish.

Care & Use:

- Wash, rinse and dry the knife before using it for the first time.
- Hand-wash with the soft side of sponge & mild detergent; rinse & dry with a soft cloth.
- Avoid from using liquid or powder detergent containing bleach or highly acidic substance.
- Sharpen with stone sharpener to maintain the sharpness.
- Do not attempt to cut, hit or chop frozen products or bones. It can cause the blade chip or break.
- Not recommended to cut small bones in fish or meat.



S-154-01 51031 1.5MM SANTOKU KNIFE–

SIZE : L 17 cm

THICKNESS : 1.5 mm

Santoku, literally mean “three virtues” or “three purposes” is a Japanese general-purpose kitchen knife. Much like a western chef knife they are versatile and applicable to variety of cutting tasks. The named is name because abilities to use for dicing, mincing and slicing for boneless meat, fish and vegetables.

Care & Use:

- Wash, rinse and dry the knife before using it for the first time.
- Hand-wash with the soft side of sponge & mild detergent; rinse & dry with a soft cloth.
- Avoid from using liquid or powder detergent containing bleach or highly acidic substance.
- Sharpen with stone sharpener to maintain the sharpness.
- Do not attempt to cut, hit or chop frozen products or bones. It can cause the blade chip or break.



S-154-02 51182 1.5MM GYUTO KNIFE–

SIZE : L 18.5 cm

THICKNESS : 1.5 mm

Gyuto literally means “beef sword”, it originally designed for slicing and disjuncting large cuts of meat. The Japanese version of the classic western style chef knife as a versatile, multi-purpose knife for cutting the vast majority of meats, fish, vegetable and fruits.

Care & Use:

- Wash, rinse and dry the knife before using it for the first time.
- Hand-wash with the soft side of sponge & mild detergent; rinse & dry with a soft cloth.
- Avoid from using liquid or powder detergent containing bleach or highly acidic substance.
- Sharpen with stone sharpener to maintain the sharpness.
- Do not attempt to cut, hit or chop frozen products or bones. It can cause the blade chip or break



- **S-155-01** 51190 2.5MM SASHIMI KNIFE–
SIZE : **L 21 cm**
THICKNESS : **2.5 mm**
- **S-155-02** 51191 2.5MM SASHIMI KNIFE–
SIZE : **L 24 cm**
THICKNESS : **2.5 mm**
- **S-155-03** 51192 2.5MM SASHIMI KNIFE–
SIZE : **L 27 cm**
THICKNESS : **2.5 mm**
- **S-155-04** 51193 2.5MM SASHIMI KNIFE–
SIZE : **L 30 cm**
THICKNESS : **2.5 mm**

Yanagiba or Sashimi Knife is a knife that designed to slice thin slices of fish for sushi and sashimi. The long blade knife is ability to slice through an ingredient in long uninterrupted strokes. Preserving its integrity and freshness. This knife is perfect to cut salmon, tuna fillet into sashimi for on nigari.

Care & Use:

- Wash, rinse and dry the knife before using it for the first time.
- Hand-wash with the soft side of sponge & mild detergent; rinse & dry with a soft cloth.
- Avoid from using liquid or powder detergent containing bleach or highly acidic substance.
- Sharpen with stone sharpener to maintain the sharpness.
- Do not attempt to cut, hit or chop frozen products or bones. It can cause the blade chip or break

CHINESE KNIVES & CUTTERS



S-155-05 1645 WOODEN
HANDLE VEGETABLE KNIFE –
SIZE : **L 8”**



Authentic 55 Heavy Duty Cleaver
Knife Chopper with Wooden
Handle - Stainless Steel – SIZE :
6.(S) – SIZE: **L 178mm,**
THICKNESS: **3mm**
7.(M) – SIZE: **L 187mm,**
THICKNESS: **3mm**
8.(L) – SIZE : **L 197mm,**
THICKNESS: **3mm**



Authentic 55 Heavy Duty Cleaver
Knife Chopper with Wooden Handle -
Forged Stainless Steel – SIZE :
S-155-09 (S) – SIZE: **L 178mm,**
THICKNESS: **3mm**
10(M) – SIZE: **L 187mm,**
THICKNESS: **3.5mm**
11(L) – SIZE : **L 197mm,**
THICKNESS: **4mm**



- **S-156-01 QCC1811BS 2# CHINESE CLEAVER–**
SIZE : **L 18cm x W 11.5cm**
TOTAL LENGTH : **29cm**
- **S-156-02 QCC1912BS 1# CHINESE CLEAVER -**
SIZE : **L 19cm x W 12.5cm**
TOTAL LENGTH : **30cm**

Chinese Cleaver is a massive knife that necessary for butchery, especially when chopping through bone or large joints. This Chinese Cleaver does the tough job of cutting through seafood and poultry. With it's crafted from high carbon steel, traditional hand forged method that assures for excellent cutting performance. Although cleaver are not necessary for the casual cook, but you should have at least one in the kitchen to help you chopping the chicken bones or rack of ribs effortlessly.

Features:

- Traditional 3 layers hand forged with Iron and T12A High Carbon Steel.
- High Carbon Core gives excellent hardness and prolong sharpness, outside layers of iron provide toughness and also protection to the core.
- Strong and thick blade able to chop through bones or seafood easily.
- Wooden knife handle for secure and comfortable grip.
- Perfect tool for chopping and mincing.

Care and use:

- Wash, rinse and dry the product before using it for the first time.
- To protect the blade edge, do not use it to chop on frozen meat and avoid cutting on hard surface such as stone, glass or metal.
- Do not put into dishwasher.
- Hand-wash with mild detergent and soft side sponge; rinse and dry immediately with kitchen towel after washed.
- Avoid from using liquid or powder detergent containing bleach or highly acidic substance.
- If not used for long period need to apply layer of cooking oil and wrapped to store.
- Store the knife in a safe place such as knife stand or block to protect its edge and prevent injury.
- Recommended sharpen this product with sharpening stone.

Warning:

- The blade edge is extremely sharp, keep this product out of reach of children.
- Wash and dry carefully, keeping sharp edge away from your hands.
- Watch out for the sharp cutter edge and eliminate direct hand touch.
- Don't attempt to catch a knife when it is falling, better it hits the floor than cut your hand.



- **S-157-01** QCC1811SS-BE 2# S/STEEL
CHINESE CLEAVER–
SIZE : L 18cm x W 11.5cm
TOTAL LENGTH : 28.5cm
- **S-157-02** QCC1912SS-BE 1# S/STEEL
CHINESE CLEAVER-
SIZE : L 19cm x W 12.5cm
TOTAL LENGTH : 29.5cm

Stainless Steel Chinese Cleaver is a massive knife that necessary for butchery, especially when chopping through bone or large joints. This Stainless Steel Chinese Cleaver does the tough job of cutting through seafood and poultry. Although cleaver are not necessary for the casual cook, but you should have at least one in the kitchen to help you chopping the chicken bones or rack of ribs effortlessly.

Features:

- Crafted from 420J2 Stainless Steel, prolong sharpness and toughness.
- Highly corrosion resistant steel.
- Strong and thick blade able to chop through bones or seafood easily.
- Colour coded knife handle are designed to prevent cross-contamination of food.
- Perfect tool for chopping and mincing.

Care and use:

- Wash, rinse and dry the product before using it for the first time.
- To protect the blade edge, do not use it to chop on frozen meat and avoid cutting on hard surface such as stone, glass or metal.
- Do not put into dishwasher.
- Hand-wash with mild detergent and soft side sponge; rinse and dry immediately with kitchen towel after washed.
- Avoid from using liquid or powder detergent containing bleach or highly acidic substance.
- Store the knife in a safe place such as knife block to protect its edge and prevent injury.
- Recommended sharpen this product with sharpening stone.

Warning:

- The blade edge is extremely sharp, keep this product out of reach of children.
- Wash and dry carefully, keeping sharp edge away from your hands.
- Watch out for the sharp cutter edge and eliminate direct hand touch.
- Don't attempt to catch a knife when it is falling, better it hits the floor than cut your hand.



- **S-158-01** QCK2090SS-GN 3# S/STEEL
CHINESE KNIFE–
SIZE : **L 20cm x W 9cm**
TOTAL LENGTH : **30.5cm**
- **S-158-02** QCK2195SS-GN 2# S/STEEL
CHINESE KNIFE-
SIZE : **L 21cm x W 9.5cm**
TOTAL LENGTH : **31.5cm**

Stainless Steel Chinese Knife (Caidao), is a multipurpose tool that can accomplish most cutting tasks in the kitchen. The deep and flat blade make them perfectly slicing veggie or meat into thinner slice. While Chinese food preparation requires a significant amount of slicing, Stainless Steel Chinese Knife is an essential tools for preparation diverse of Asian Food. Keenly sharp edge and lightweight that ensure your excellent cutting performance in the daily kitchen tasks.

Features:

- Crafted from 420J2 Stainless Steel, prolong sharpness and toughness.
- Highly corrosion resistant steel.
- Sharp and thin blade works extremely well for cutting and slicing.
- Colour coded knife handle are designed to prevent cross-contamination of food.
- Perfect tool for cutting, slicing and dicing.

Care and Use:

- Wash, rinse and dry the product before using it for the first time.
- To protect the blade edge, do not chopping on hard bones and avoid cutting on hard surface such as stone, glass or metal.
- Do not put into dishwasher.
- Hand-wash with mild detergent and soft side sponge; rinse and dry immediately with kitchen towel after washed.
- Avoid from using liquid or powder detergent containing bleach or highly acidic substance.
- Store the knife in a safe place such as knife block to protect its edge and prevent injury.
- If no use for longer period must clean and wipe with dry cloth before storing.
- Recommended sharpen this product with sharpening stone.

Warning:

- The blade edge is extremely sharp, keep this product out of reach of children.
- Wash and dry carefully, keeping sharp edge away from your hands.
- Watch out for the sharp cutter edge and eliminate direct hand touch.
- Don't attempt to catch a knife when it is falling, better it hits the floor than cut your hand.

KNIFE



- **S-159-01** K-501 UTILITY KNIFE
W.HANDLE – SIZE : 5"
PACKING : **50DOZ/CTN**
- **S-159-02** K-502 PARING KNIFE
W.HANDLE – SIZE : 5"
PACKING : **50DOZ/CTN**
- **S-159-03** K-503 FRUIT KNIFE
W.HANDLE – SIZE : 4"
PACKING : **50DOZ/CTN**
- **S-159-04** K-504 CHEESE KNIFE
W.HANDLE – SIZE : 3"
PACKING : **50DOZ/CTN**
- **S-159-05** K-511 UTILITY KNIFE
P.HANDLE – SIZE : 5"
PACKING : **50DOZ/CTN**
- **S-159-06** K-512 PARING KNIFE
P.HANDLE – SIZE : 5"
PACKING : **50DOZ/CTN**



- **S-159-07** K-001 CARVING KNIFE
RED P. HANDLE – SIZE : 3"
PACKING : **100DOZ/CTN**
- **S-159-08** K-002 CARVING KNIFE
(KOM-KOM) – SIZE : 2"
PACKING : **10DOZ/CTN**
- **S-159-09** K-192 FRUIT KNIFE
P.HANDLE –
SIZE : 2.5" PACKING : **50DOZ/CTN**
- **S-159-10** K-193 PARING KNIFE
P.HANDLE –
SIZE : 3" PACKING : **50DOZ/CTN**
- **S-159-11** K-194 PARING KNIFE
P.HANDLE –
SIZE : 4" PACKING : **50DOZ/CTN**
- **S-159-12** K-195 UTILITY KNIFE
P.HANDLE –
SIZE : 5" PACKING : **50DOZ/CTN**
- **S-159-13** K-402 COOK KNIFE
P.HANDLE –
SIZE : 5.5" PACKING : **20DOZ/CTN**

CLEAVER KNIFE & COOK KNIFE



- **S-160-01** K-810 CLEAVER KNIFE P.HANDLE – SIZE : 6.5" PACKING : **20DOZ/CTN**
- **S-160-02** K-816 CLEAVER KNIFE P.HANDLE – SIZE : 6.5" PACKING : **20DOZ/CTN**
- **S-160-03** K-21 COOK KNIFE W.HANDLE – SIZE : 8" PACKING : **15DOZ/CTN**
- **S-160-04** K-22 COOK KNIFE W.HANDLE – SIZE : 8" PACKING : **15DOZ/CTN**
- **S-160-05** K-21-P COOK KNIFE P.HANDLE – SIZE : 8" PACKING : **15DOZ/CTN**
- **S-160-06** K-22-P COOK KNIFE P.HANDLE – SIZE : 8" PACKING : **15DOZ/CTN**



- **S-160-07** K-171 COOK KNIFE W.HANDLE – SIZE : 6.5" PACKING : **20DOZ/CTN**
- **S-160-08** K-172 COOK KNIFE W.HANDLE – SIZE : 7" PACKING : **20DOZ/CTN**
- **S-160-09** K-173 COOK KNIFE W.HANDLE – SIZE : 7" PACKING : **20DOZ/CTN**
- **S-160-10** K-171-P COOK KNIFE P.HANDLE – SIZE : 6.5" PACKING : **20DOZ/CTN**
- **S-160-11** K-172-P COOK KNIFE P.HANDLE – SIZE : 7" PACKING : **20DOZ/CTN**
- **S-160-12** K-173-P COOK KNIFE P.HANDLE – SIZE : 7" PACKING : **20DOZ/CTN**

BONE CLEAVER KNIFE W.HANDLE



- **S-161-01** K-830 – SIZE : 6"
PACKING : 10DOZ/CTN
- **S-161-02** K-835 – SIZE : 6.5"
PACKING : 6DOZ/CTN
- **S-161-03** K-840 – SIZE : 7"
PACKING : 6DOZ/CTN
- **S-161-04** K-850 – SIZE : 8"
PACKING : 6DOZ/CTN

CHINESE BONE CLEAVER KNIFE



- **S-161-05** K-812 – SIZE : 8.5"
PACKING : 6DOZ/CTN
- **S-161-06** K-813 – SIZE : 8"
PACKING : 6DOZ/CTN
- **S-161-07** K-814 – SIZE : 9"
PACKING : 6DOZ/CTN
- **S-161-08** K-812-P – SIZE : 8.5"
PACKING : 6DOZ/CTN
- **S-161-09** K-813-P – SIZE : 8"
PACKING : 6DOZ/CTN

JAVA KNIFE P.HANDLE



- **S-162-01** K-474 – SIZE : 4"
PACKING : 40 DOZ/CTN
- **S-162-02** K-475 – SIZE : 5"
PACKING : 40 DOZ/CTN
- **S-162-03** K-476 – SIZE : 6"
PACKING : 20 DOZ/CTN
- **S-162-04** K-477 – SIZE : 7"
PACKING : 20 DOZ/CTN
- **S-162-05** K-478 – SIZE : 8"
PACKING : 20 DOZ/CTN
- **S-162-06** K-479 – SIZE : 9"
PACKING : 20 DOZ/CTN

SCISSORS



- **S-162-07** F1501 SCISSORS – SIZE : L 134mm
PACKING : 24 PACK X 12 UNIT
- **S-162-08** F1502 SCISSORS – SIZE : L 154mm
PACKING : 24 PACK X 12 UNIT
- **S-162-09** F1503 SCISSORS – SIZE : L 174mm
PACKING : 24 PACK X 12 UNIT
- **S-162-10** F1504 SCISSORS – SIZE : L 192mm
PACKING : 24 PACK X 12 UNIT

CHOPPING BOARD

ROUND CHOPPING BOARD (WHITE)



- S-163-01 2503W – SIZE : D 25cm x H 3cm
- S-163-02 3005W – SIZE : D 30cm x H 5cm
- S-163-03 3505W – SIZE : D 35cm x H 5cm
- S-163-04 4005W – SIZE : D 40cm x H 5cm
- S-163-05 4505W – SIZE : D 45cm x H 5cm
- S-163-06 5005W – SIZE : D 50cm x H 5cm

Features:

- Reversible
- Long Last Durability
- Non-Absorbent & Odourless
- Non-Porous & Non-Toxic
- Colour Coded to Help Prevent Cross-Contamination of Foods

Care & Use:

- Wash, rinse and dry before using it for the first time.
- Wash with hot and soapy water after each use; rinse and dry immediately after washed or dry with clean paper towels.
- Store in a dry area away from extreme temperatures.



COLOUR CODED CHOPPING BOARD

- S-163-07 4010W – SIZE : D 40cm x H 10cm
- S-163-08 4510W – SIZE : D 45cm x H 10cm
- S-163-09 5010W – SIZE : D 50cm x H 10cm



Features:

- Reversible
- Long Last Durability
- Non-Absorbent & Odorless
- Non-Porous & Non-Toxic
- Colour Coded to Help Prevent Cross-Contamination of Foods



Care & Use:

- Wash, rinse and dry before using it for the first time.
- Wash with hot and soapy water after each use; rinse and dry immediately after washed or dry with clean paper towels.
- Store in a dry area away from extreme temperatures.



SHARPENING STONE

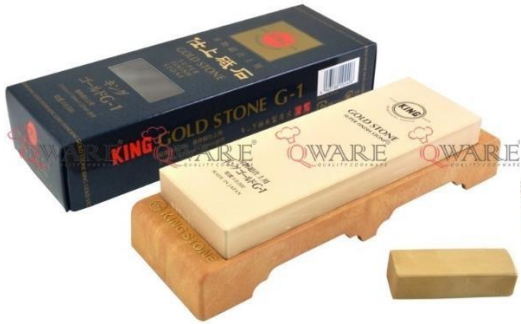

**S-165-01 G-1 NO.8000 "KING" GOLD SHARPENING STONE –
SIZE : L 21 cm x W 7.3 cm x H 2.2 cm**



**S-165-02 NO.1000 "KING" SHARPENING STONE –
SIZE : L 20.7 cm x W 6.6 cm x H 3.4 cm**



**S-165-03 NO.800 "KING" SHARPENING STONE –
SIZE : L 20.7 cm x W 6.6 cm x H 3.4 cm**



**S-165-04 NO.16 "SUN TIGER" SHARPENING STONE –
SIZE : L 20.5 cm x W 7.5 cm x H 5 cm**



**S-165-05 320 "SUN TIGER" SHARPENING STONE –
SIZE : L 8" x W 3" x H 2"**



**S-165-06 S-1 NO.6000 "KING" SHARPENING STONE –
SIZE : L 21 cm x W 7.3 cm x H 2.2 cm**



**S-165-07 S-2 NO.6000 "KING" SHARPENING STONE –
SIZE : L 19 cm x W 7 cm x H 2 cm**



- **S-165-08 RA-ST-O-832 SHARP STONE – SIZE : 8"x3"X2"**
- **S-165-09 RA-ST-O-08 CARBORUNDUM STONE – SIZE : 8"**
- **S-165-10 RA-ST-O-06 CARBORUNDUM STONE – SIZE : 6"**

WHETSTONE SERIES



S-166-01 MDS2 ANTI-SLIP COMBINATION
WHETSTONE (120/240 GRIT) – PACKING : **36 PCS/CTN**



S-166-02 MDS3 WHETSTONE (1000/6000 GRIT) –
SIZE : L 180mm x W 60mm x H 25mm
PACKING : **40 PCS/CTN**

12" ROD KNIFE SHARPENER



S-166-03 CGN28-12A – SIZE : 12"
PACKING : **120 PCS/CTN**

CAN OPENER



T-167-01 TW-WNNO HEAVY DUTY CAN OPENER (TAIWAN)
SIZE : 40 cm
PACKING : 8 PCS/CTN



T-167-02 WNNO-1 REPLACEMENT BLADE FOR CAN OPENER
SIZE : L 4.2 cm x W 1.6 cm



T-167-03 WNNO-2 REPLACEMENT GEAR FOR CAN OPENER
SIZE : D 2.5 cm



T-167-04 800 TAIWAN CAN OPENER
SIZE : L 17.5 cm



T-167-05 US-800 JAPAN IRON CAN OPENER
SIZE : L 17.5 cm
 This can opener are simple, fast, and efficient way to open cans with precision and reliability. Gear driven cutter and skip-proof feed wheel make it smooth and easy to use.



T-167-06 S2-1316 CAN OPENER
SIZE : L 25.5 cm x W 4.5 cm



T-167-07 US-500 JAPAN IRON CAN OPENER
SIZE : L 17 cm
 This can opener are simple, fast, and efficient way to open cans with precision and reliability. Gear driven cutter and skip-proof feed wheel make it smooth and easy to use.

VEGETABLE CUTTER, PEELER & GRATER

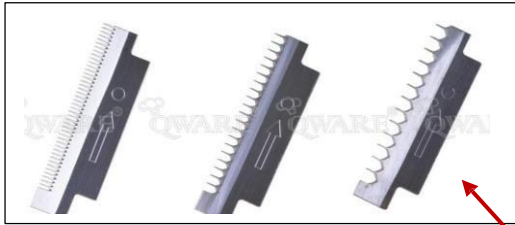

T-169-01 K-91 JAPAN STEEL VEGETABLE CUTTER – SIZE : L 28 cm x W 11 cm x H 17 cm



T-169-02 PG20R-02 PROFESSIONAL GRATER (RED) – SIZE : L 20.2 cm x W 2.6 cm



T-169-03 PG20Y-01 PROFESSIONAL GRATER (YELLOW) – SIZE : L 20.2 cm x W 2.6 cm



T-169-04 0814 STAINLESS STEEL GRATER – SIZE : L 20 cm x W 8.6 cm



T-169-05 1912 MULTI PURPOSE GRATER (JAPAN) – SIZE : L 22.9 cm x W 9 cm



T-169-06 200921 4 SIDED S/STEEL GRATER – PACKING : 120 PCS/CTN



STAINLESS STEEL GINGER GRATER

- **T-169-07 SG-O 102095 OVAL – SIZE : 70mm x 145mm PACKING : 360PCS/CTN**
- **T-169-08 SG-R 102096 RECT. – SIZE : 70mm x 145mm PACKING : 360PCS/CTN**



T-170-01 8217 WIDE PEELER (JAPAN) –
SIZE : L 17 cm x W 10.3 cm



T-170-02 802611 JAPAN PEELER –
SIZE : L 12 cm x W 6 cm



- **T-170-03 HL-P-411 411**
PEELER ORIGINAL
- **T-170-04 HL-P-118 118**
PEELER ORIGINAL
- **T-170-05 HL-P-888 888**
PEELER ORIGINAL



- **T-170-06 217 PRO PEELER –**
PACKING : 10DOZ/CTN
- **T-170-07 218 PRO SLICER –**
PACKING : 10DOZ/CTN



ICE CREAM SCOOP

www.dmhygiene.com.my 018-6660642



U-171-01 CIS30 CLR HDL
S/STEEL ICE CREAM SCOOP –
Capacity : **1 Oz**
PACKING : **55 PCS/CTN**



U-171-02 CIS20 CLR HDL
S/STEEL ICE CREAM SCOOP –
Capacity : **1 2/3 Oz**
PACKING : **55 PCS/CTN**



U-171-03 CIS16 CLR HDL
S/STEEL ICE CREAM SCOOP –
Capacity : **2 Oz**
PACKING : **55 PCS/CTN**



U-171-04 CIS12 CLR HDL
S/STEEL ICE CREAM SCOOP –
Capacity : **3 1/3 Oz**
PACKING : **55 PCS/CTN**



U-171-05 CIS6 CLR HDL
S/STEEL ICE CREAM SCOOP –
Capacity : **3 2/3 Oz**
PACKING : **60 PCS/CTN**



U-171-06 CIS10 CLR HDL
S/STEEL ICE CREAM SCOOP –
Capacity : **4 2/3 Oz**
PACKING : **60 PCS/CTN**





PIZZA PLATE (COATING)



- U-172-01 C-E-07 – SIZE : 7"
- U-172-02 C-E-08 – SIZE : 8"
- U-172-03 C-E-09 – SIZE : 9"
- U-172-04 C-E-10 – SIZE : 10"
- U-172-05 C-E-11 – SIZE : 11"
- U-172-06 C-E-12 – SIZE : 12"
- U-172-07 C-E-13 – SIZE : 13"
- U-172-08 C-E-14 – SIZE : 14"

PIZZA SUPPLIES



U-173-01 23506 ALUMINIUM BLADE PIZZA PEEL –
SIZE : L 89.5 cm x W 35.5 cm x H 30.7 cm

This pizza peel is designed with sturdy aluminum construction to transfer pizzas to and from the oven with professional ease. Its thin-gauge paddle can easily slide under pizza. This aluminum pizza peel includes a long wooden handle to keep your hands away from the heat.



U-173-02 PG-D STAINLESS STEEL PIZZA PAN
GRIPPER – SIZE : L 19.7 cm x W 6.5 cm x H 3.5 cm



U-173-03 WPP-880 WOOD HANDLE PIZZA
PEEL– SIZE : D 16.5 cm x L 34.3 cm



U-173-04 PC-4 BLACK HANDLE PIZZA CUTTER – SIZE : D 10 cm

The 4" Pizza Cutter features a sanitary, stainless steel wheel and finger guards. It also has a black, comfort-molded handle.



U-173-05 WPS-6PH BLACK HANDLE PIZZA
TURNER – SIZE : L 27 cm x W 2.5 cm x H 6 cm

Durable, professional-grade tool which can be used in the home or in the restaurant.



U-173-06 MG1018 STAINLESS STEEL PIZZA
TURNER – SIZE : 10" x 17"



TURNER



- **U-175-01** YJ6910 JAPANESE STYLE TURNER – SIZE : **L 10.5 cm**
- **U-175-02** YJ6912 JAPANESE STYLE TURNER – SIZE : **L 12 cm**



U-175-03 WSCR-6PH BLACK HANDLE MULTI PURPOSE TURNER – SIZE : **L 30 cm x W 7 cm**

Durable, professional-grade tool which can be used in the home or in the restaurant. Perfect for lifting those thick slices of fish, hamburger patties or steaks off the grill. Also good for serving enchiladas, casseroles, grilled onions and other foods.



U-175-04 WTSD-10PH BLACK HANDLE SOLID BURGER TURNER – SIZE : **L 38.5 cm x W 7 cm**

Durable, professional-grade tool which can be used in the home or in the restaurant. Perfect for lifting those thick slices of fish, hamburger patties or steaks off the grill. Also good for serving enchiladas, casseroles, grilled onions and other foods.



U-175-05 WTPF-10PH BLACK HANDLE PERFORATED BURGER TURNER – SIZE : **L 38.5 cm x W 7 cm**

Durable, professional-grade tool which can be used in the home or in the restaurant. Perforated offset turner has extra long stainless steel blade. Durably constructed for lasting use.



- **U-175-06** RA-KT-SB-090 TEPPAN TURNER – SIZE : **9CM**
- **U-175-07** RA-KT-SB-105 TEPPAN TURNER – SIZE : **10.5CM**
- **U-175-08** RA-KT-SB-120 TEPPAN TURNER – SIZE : **12CM**



SPATULA



- **U-177-01** ACS-08 8" PLASTIC HANDLE ANGULAR SPATULA – SIZE : L 20 cm x W 2.7 cm
- **U-177-02** ACS-10 10" PLASTIC HANDLE ANGULAR SPATULA – SIZE : L 25 cm x W 3 cm
- **U-177-03** ACS-12 12" PLASTIC HANDLE ANGULAR SPATULA – SIZE : L 30 cm x W 3.5 cm

The stainless steel angular spatula is easy to clean and has a black plastic handle that ensures a comfortable and stable grip. Use this spatula to icing your famous cupcakes, cakes, and other baking specialties.



- **U-177-04** ICS-8 8" PLASTIC HANDLE SPATULA – SIZE : L 20 cm x W 3.5 cm
- **U-177-05** ICS-10 10" PLASTIC HANDLE SPATULA – SIZE : L 25 cm x W 3.5 cm
- **U-177-06** ICS-12 12" PLASTIC HANDLE SPATULA – SIZE : L 30 cm x W 3.5 cm

The stainless steel spatula is easy to clean and has a black plastic handle that ensures a comfortable and stable grip. Use this spatula to icing your famous cupcakes, cakes, and other baking specialties.



U-177-07 WS-6PH 4" PLASTIC HANDLE SPATULA –
SIZE : L 23.4 cm x L 12 cm x W 3.3 cm

The 4" Spatula is easy to clean and has a black plastic handle that ensures a comfortable and stable grip. Use this spatula to icing your famous cupcakes, cakes, and other baking specialties.



U-177-08 WSCR-4PH BLACK HANDLE CLEANING SPATULA –
SIZE : L 24.5 cm x W 10 cm

Durable, professional-grade tool which can be used in the home or in the restaurant.



FOOD TONG



- **V-179-01** FFT9 BLACK FROSTED S/STEEL FOOD TONG – SIZE : 9”
PACKING : 72PCS/CTN
- **V-179-02** FFT12 BLACK FROSTED S/STEEL FOOD TONG – SIZE : 12”
PACKING : 72PCS/CTN
- **V-179-03** FFT14 BLACK FROSTED S/STEEL FOOD TONG – SIZE : 14”
PACKING : 72PCS/CTN
- **V-179-04** FFT16 BLACK FROSTED S/STEEL FOOD TONG – SIZE : 16”
PACKING : 72PCS/CTN



V-179-05 506-6 S/STEEL ICE TONG – SIZE : 6”
PACKING : 1000PCS/CTN



V-179-06 10173 SEMI-ROUND S/STEEL BUFFET SERVING TONG – SIZE : 9.5”
PACKING : 240PCS/CTN



V-179-07 10176 ROUND S/STEEL BUFFET SERVING TONG – SIZE : 9.5”
PACKING : 240PCS/CTN



V-179-08 A181 18.8 S/STEEL SERVING TONG – SIZE : 8” , 10”
PACKING : 240PCS/CTN



V-179-09 H-086 18.8 S/STEEL FOOD TONG – SIZE : 10.5”
PACKING : 240PCS/CTN



V-179-10 PC6008 PC TRANSPARENT FOOD TONG – SIZE : L 21.5 cm x W 2.9 cm



V-180-01 JB2309 FOOD TONG – SIZE : L 10"

This scissor type food tongs would be a great addition to any commercial kitchen. Grab anything and everything hot out of the oven or barbecue pit without burning your hands. With the scissor grip and rounded tips, you can turn tender meats without worrying you will lose your grip, or break the meat off the bone. These tongs are designed for heavy use and are ideal for use in kitchens, buffets, banquets and catered events.

LOCKING TONG

- **V-180-02 QLT9RD-SI 9" HEAVY DUTY S/STEEL SILICONE TIP LOCKING TONG (RED) – SIZE : L 22.5 cm**
- **V-180-03 QLT12RD-SI 12" HEAVY DUTY S/STEEL SILICONE TIP LOCKING TONG (RED) – SIZE : L 30 cm**



In Western cuisine, it is always easier to manage the food with a tong than any other utensils while cooking. I.e., steak, shrimp, pasta and barbeque. Being aesthetically pleasing yet practical, Stainless Steel Locking Tong is ideal for lifting, turning and transferring food, whether you're panfrying or sautéing. Furthermore, the tip would not scratch the surface of the pan, thus it is safe for use with all types of cookware, including non-stick.

Features

1. High Quality Stainless Steel

- Although being lightweight, it is durable and sturdy.

2. High Versatility

- Can be paired with all type of cookware, including non-stick.

3. Hygiene & Sanitary

- Easy to keep clean, do not attract bacteria and do not pick up food particles.

4. Easy Storage

- Equipped with smart locking mechanism with circular loop that allows compact storage.

Care & Use:

- Do not leave the tong on hot pan.
- Use a soft sponge with dishwashing liquid to clean the locking tong after each use.
- Dry with clean cloth after washed.
- Hand wash recommended.

Caution:

- Do not leave it near or under high heat or open flame.
- Keep it away from highly acidic or alkaline substances.



- **V-181-01** T503-9B 9" S/S NYLON TIP LOCKING TONG (BLACK) – SIZE : **L 22.5 cm**
- **V-181-02** T503-12B 12" S/S NYLON TIP LOCKING TONG (BLACK) – SIZE : **L 30 cm**

In Western cuisine, it is always easier to manage the food with a tong than any other utensils while cooking. I.e, steak, shrimp, pasta and barbeque. Being aesthetically pleasing yet practical, Stainless Steel Locking Tong is ideal for lifting, turning and transferring food, whether you're panfrying or sautéing. Furthermore, the tip would not scratch the surface of the pan, thus it is safe for use with all types of cookware, including non-stick.

Features

1. High Quality Stainless Steel

- Although being lightweight, it is durable and sturdy.

2. High Versatility

- Can be paired with all type of cookware, including non-stick.

3. Hygiene & Sanitary

- Easy to keep clean, do not attract bacteria and do not pick up food particles.

4. Easy Storage

- Equipped with smart locking mechanism with circular loop that allows compact storage.

Care & Use:

- Do not leave the tong on hot pan.
- Use a soft sponge with dishwashing liquid to clean the locking tong after each use.
- Dry with clean cloth after washed.
- Hand wash recommended.

Caution:

- Do not leave it near or under high heat or open flame.
- Keep it away from highly acidic or alkaline substances



CHAFING DISH

ROUND ROLL TOP CHAFING DISH



1.CF-0721 ROUND ROLL TOP CHAFING DISH – SIZE : \varnothing 480xH450mm WEIGHT : 5.5KG THICKNESS : 1.5mm
❖ Mirror-Polished Finish

BELL DOME CHAFING DISH



V-183-02 BD-2012 9.0L BELL DOME CHAFING DISH – SIZE : 540mm x 540mm x 770mm

OPTIONAL ACCESSORIES



V-183-03 RF36-2 ROUND FOOD PAN – SIZE : \varnothing 36 x 6.5mm WEIGHT : 680G THICKNESS : 0.6mm



V-183-04 RWP72138 ROUND WATER PAN – SIZE : \varnothing 38 x 10mm WEIGHT : 690G THICKNESS : 1.5mm



V-183-05 SC702 S/STEEL SPINT CANISTER – WEIGHT : 115G THICKNESS : 0.4mm PACKING : 200 PCS/CTN



V-184-01 SR-RFP389
S/STEEL FOOD PAN –
SIZE : 38cm x 9cm
PACKING : 6 PCS/CTN



V-184-02 SR-RFP4010
S/STEEL WATER PAN –
SIZE : 40cm x 10cm
PACKING : 6 PCS/CTN

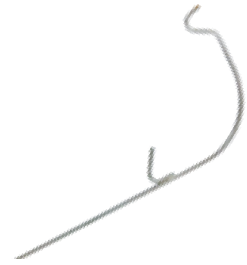

V-184-03 SR-BDH73 S/STEEL
LID HOOK STAND

COFFEE SERVER, COFFEE DECANTER & WARMER



V-184-04 TP2L S/STEEL
TEA POT – Capacity : 2L
PACKING : 24 PCS/CTN



V-184-05 SWP-64 S/STEEL WATER
PITCHER – Capacity : 64 Oz
PACKING : 24 PCS/CTN



V-184-06 THP230 COFFEE
WARMER - PACKING : 6 PCS/CTN



V-184-07 SR-23959 SUNNEX
S/STEEL BOTTOM COFFEE
DECANTER– Capacity : 1.8L
PACKING : 24 PCS/CTN



V-184-08 8895 KINOX
S/STEEL BOTTOM COFFEE
DECANTER– Capacity : 1.8L
PACKING : 24 PCS/CTN



V-184-09 SD-8890 A.D
S/STEEL BOTTOM COFFEE
DECANTER– Capacity : 1.8L
PACKING : 24 PCS/CTN

STOVE & COOKING EQUIPMENTS



ELECTRIC RICE COOKER

- **W-185-01** AEROGAZ AZ-1008RC – Capacity : **8.5L**
- **W-185-02** BUTTERFLY, AEROGAZ – Capacity : **10L**



W-185-03 GF 6000 D/STOVE S/S



W-185-05 181-2 BUTTERFLY L/P GAS REGULATOR



W-185-06 181-1 BUTTERFLY H/P GAS REGULATOR



W-185-04 STOVE DRUM



W-185-07 C40 BOWL & BURNER C/SET



W-185-08 C-50S C20 DAPUR-BOWL WITH HOLE



W-185-09 C-55T 3 PIPE BURNER C50 STOVE



W-185-10 C30 DAPUR



W-185-11 30ACB A600 STOVE IRON



W-186-01 5C BOWL & BURNER COMPLETE SET (Ch) 2 PIPE HD H/P DAPUR W/BOWL



W-186-02 TL129S H/P STOVE (B) – RINGAN – HIGH PRESSURE SHEET IRON BOWL



W-186-03 GF12B-1 2 PIPE BURNER



W-186-04 C-50S 6B BURNER ONLY



W-186-05 110C HIGH PRESSURE GAS STOVE – BURNER ONLY

COMMERCIAL MACHINE

COMMERCIAL DEEP FRYER



- **W-187-01** CF-81B S/STEEL ELECTRIC DEEP FRYER – Capacity : 6 C PACKING : 1 PCS/CTN
- **W-187-02** CF-82B S/STEEL ELECTRIC DEEP FRYER – Capacity : 2 x 6 C PACKING : 1 PCS/CTN

ACCESSORIES



- **W-187-03** FB8182 S/STEEL FRYING BASKET – SIZE : 18cm x 20cm x 11cm

www.dmhygiene.com.my 018-6660642

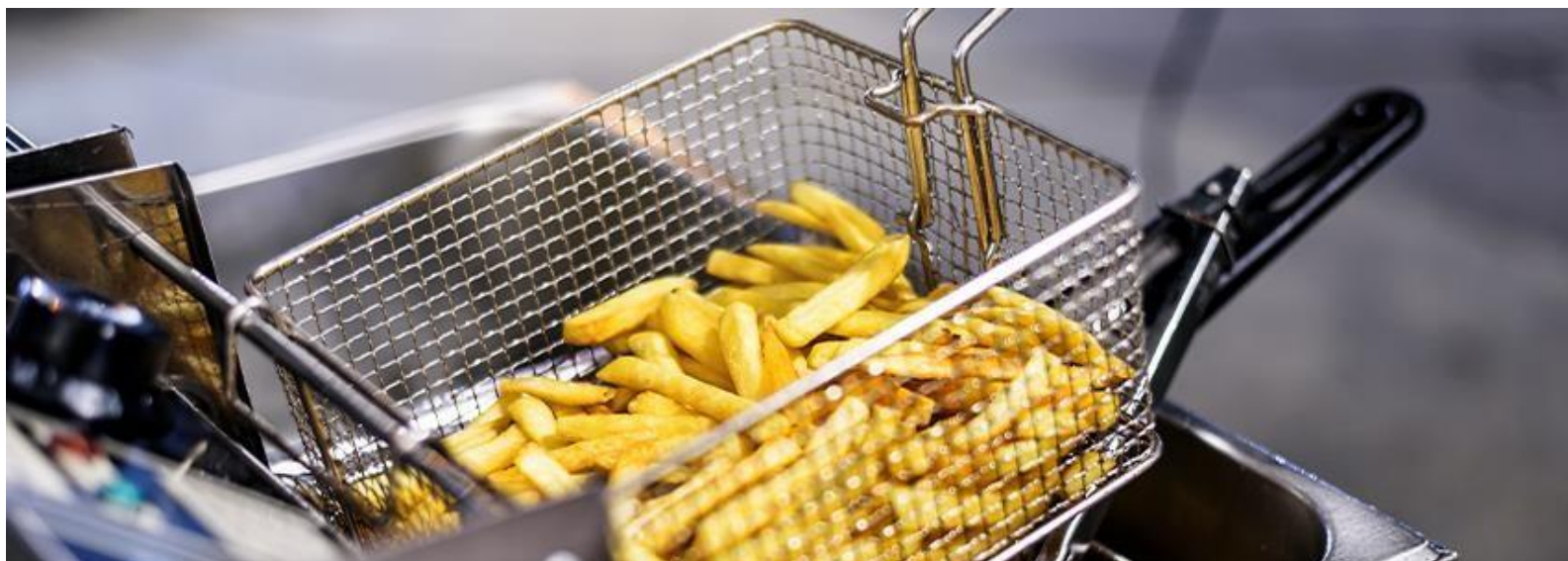

COMMERCIAL BLENDER



W-188-01 WCF-767-3JC Blender Jug W/Cover 2.0L



W-188-05 Opener



W-188-02 WCF-767-3MS Blender stick



W-188-03 WCF-767-3FB Jug Fixing Board



W-188-04 WCF-767-3D Drive Socket



W-188-06 WCF-767-3B Heavy Duty Blade



W-188-07 WCF-767-3 COMMERCIAL BLENDER
PACKING : 4 SET / CTN



COMMERCIAL MACHINE



**W-189-01 SYX-01 SINGLE MILK SHAKE MACHINE – SIZE : 210 mm x 210 mm x 560 mm
PACKING : 4 PCS/CTN**



**W-189-02 A108 S/STEEL COMMERCIAL ICE CRUSHER – SIZE : 430 mm x 200 mm x 320 mm
PACKING : 4 PCS/CTN**

DISPENSER

COFFEE URN



- **W-189-03 CUN 13S COFFEE URN – SIZE : 270mm x 560mm
Capacity : 13 L**
- **W-189-04 CUN 20S COFFEE URN – SIZE : 270mm x 600mm
Capacity : 20 L**

8.0L S/STEEL MILK DISPENSER



**W-189-05 8.0L S/STEEL MILK DISPENSER –
SIZE : 265mm x 380mm x 540mm
Capacity : 8 L**

S/STEEL JUICE DISPENSER



- **W-190-01 JD 1S S/STEEL JUICE DISPENSER –**
SIZE : 260mm x 345mm x 560mm
Capacity : 1 x 8 L
- **W-190-02 JD 2S S/STEEL JUICE DISPENSER –**
SIZE : 562mm x 345mm x 600mm
Capacity : 2 x 8 L

JUICE DISPENSER ACCESSORIES



**W-190-03 JDCS S/STEEL
HANDLE JUICE DISPENSER
COVER**



**W-190-04 JDCG GOLDEN HANDLE
JUICE DISPENSER COVER**



**W-190-05 JD 1220 JUICE
DISPENSER TAP**



**W-190-06 ICE TUBE FIXING
BOARD**



W-190-07 S/STEEL BASE



W-190-08 S/STEEL TUBE



**W-190-09 S/STEEL DRIP
TRAY**



**W-190-10 JDS-T S/STEEL
HANDLE PLASTIC DISPENSER**

COOLER / BOILER

S/STEEL BODY KEEP WARM COOLER



- **W-191-01 1108** – Capacity : **8 L** PACKING : **6 PCS/CTN**
- **W-191-02 1110** – Capacity : **10 L** PACKING : **6 PCS/CTN**
- **W-191-03 1112** – Capacity : **12 L** PACKING : **6 PCS/CTN**
- **W-191-04 1114** – Capacity : **14 L** PACKING : **6 PCS/CTN**
- **W-191-05 1116** – Capacity : **16 L** PACKING : **6 PCS/CTN**
- **W-191-06 1118** – Capacity : **18 L** PACKING : **6 PCS/CTN**

SINGLE TAP S/STEEL WATER COOLER



- **W-191-07 2011S** – Capacity : **11 L** PACKING : **1 PCS/CTN**
- **W-191-08 2018S** – Capacity : **18 L** PACKING : **1 PCS/CTN**
- **W-191-09 2028S** – Capacity : **28 L** PACKING : **1 PCS/CTN**
- **W-191-10 2038S** – Capacity : **38 L** PACKING : **1 PCS/CTN**

DOUBLE TAP S/STEEL WATER COOLER



W-191-11 2058D – Capacity : **58 L** PACKING : **1 PCS/CTN**

MULTI PURPOSE KEEP WARM S/STEEL INSULATED CONTAINER



- **W-192-01 DT-10** – Capacity : **10 L** PACKING : **8 PCS/CTN**
- **W-192-02 DT-20** – Capacity : **20 L** PACKING : **4 PCS/CTN**
- **W-192-03 DT-30** – Capacity : **30 L** PACKING : **4 PCS/CTN**
- **W-192-04 DT-40** – Capacity : **40 L** PACKING : **2 PCS/CTN**
- **W-192-05 DT-50** – Capacity : **50 L** PACKING : **2 PCS/CTN**
- **W-192-06 DT-60** – Capacity : **60 L** PACKING : **2 PCS/CTN**
- **W-192-07 DT-70** – Capacity : **70 L** PACKING : **2 PCS/CTN**

ELECTRIC SOUP WARMER



W-193-01 SK600 ELECTRIC CAST IRON BODY SOUP WARMER –
SIZE : **350mm x350mm x 380mm**
Capacity : **10L**



W-193-02 ESK1300 13L ELECTRIC CAST IRON BODY SOUP WARMER –
SIZE : **390mm x390mm x 400mm**
Capacity : **13L**



W-193-03 SW-853 10L DRUM SHAPE ELECTRIC CAST IRON BODY SOUP WARMER –
SIZE : **350mm x350mm x 380mm**
Capacity : **10L**



W-193-04 ESK1300P 13L ELECTRIC PLASTIC BODY SOUP WARMER –
SIZE : **390mm x390mm x 400mm**
Capacity : **13L**



W-193-05 ESK10P 10L ELECTRIC PLASTIC BODY SOUP WARMER –
SIZE : **350mm x350mm x 380mm**
Capacity : **10L**



W-193-06 SW-855 11L STRAIGHT ELECTRIC CAST IRON BODY SOUP WARMER –
SIZE : **400mm x400mm x 380mm**
Capacity : **11L**



CAMRY SCALE



- **X-194-01** CK905 1 KG CAMRY SCALE –
SIZE : L 217mm x W 142mm x H 250mm
PACKING : 8 PCS/CTN
- **X-194-02** CK906 2 KG CAMRY SCALE –
SIZE : L 217mm x W 142mm x H 250mm
PACKING : 8 PCS/CTN
- **X-194-03** CK904 3 KG CAMRY SCALE –
SIZE : L 217mm x W 142mm x H 250mm
PACKING : 8 PCS/CTN



- **X-194-04** CK908 30 KG CAMRY SCALE –
SIZE : L 305mm x W 210mm x H 320mm
PACKING : 2 PCS/CTN
- **X-194-05** CK900 50 KG CAMRY SCALE –
SIZE : L 305mm x W 210mm x H 320mm
PACKING : 2 PCS/CTN
- **X-194-06** CK901 100 KG CAMRY SCALE –
SIZE : L 305mm x W 210mm x H 320mm
PACKING : 2 PCS/CTN



- **X-194-07** CK907 5 KG CAMRY SCALE –
SIZE : L 258mm x W 178mm x H 314mm
PACKING : 6 PCS/CTN
- **X-194-08** CK902 10 KG CAMRY SCALE –
SIZE : L 258mm x W 178mm x H 314mm
PACKING : 6 PCS/CTN
- **X-194-09** CK917 15 KG CAMRY SCALE –
SIZE : L 258mm x W 178mm x H 314mm
PACKING : 6 PCS/CTN
- **X-194-10** CK903 20 KG CAMRY SCALE –
SIZE : L 258mm x W 178mm x H 314mm
PACKING : 6 PCS/CTN

DIGITAL SCALE & ITEMS



X-195-01 CK950 ACS-ZC73 30KG CAMRY
KITCHEN SCALE –
SIZE : L 342mm x W 300mm x H 120mm
PACKING : 4 PCS/CTN



X-195-02 CK944 ACS-JC81W 30KG CAMRY
KITCHEN SCALE –
SIZE : L 340mm x W 292mm x H 158mm
PACKING : 4 PCS/CTN



X-195-03 CK919 ACS-JE11 30KG CAMRY DIGITAL
SCALE – SIZE : L 355mm x W 235mm x H 121mm
PACKING : 4 PCS/CTN



X-195-04 CK920 ACS-JE21 30KG CAMRY DIGITAL
SCALE – SIZE : L 300mm x W 230mm x H 106mm
PACKING : 4 PCS/CTN



X-195-05 CK923 EI-01S 3 KG CAMRY DIGITAL
SCALE – SIZE : L 224mm x W 160mm x H 44mm
PACKING : 12 PCS/CTN



X-195-06 CK927 EK9270H 5 KG CAMRY
KITCHEN SCALE –
SIZE : L 221mm x W 150mm x H 20mm
PACKING : 12 PCS/CTN



X-196-01 CK926 EK3230H 5 KG CAMRY
ELECTRONIC KITCHEN SCALE –
SIZE : L 246mm x W 230mm x H 115mm
PACKING : 12 PCS/CTN



X-196-02 CK934 EHA501 200gram
SMALL HEALTH MONITOR SCALE –
SIZE : L 120mm x W 70mm x H 17mm
PACKING : 48 PCS/CTN



CONSTANT

X-196-03 14192-1F COMMERCIAL ELECTRIC SCALE –
WEIGHT: 30KG
PACKING : 5PCS/CTN



SUNNEX®

X-196-04 M9219D7 DIGITAL KITCHEN TIMER
PACKING : 100PCS/CTN



X-196-05 24HP OVEN THERMOMETER –
SIZE : 5.8cm x 7.3cm
REMARK : - 50°C to 300°C



X-196-06 3210-08 GRILL SURFACE
THERMOMETER – SIZE : 7.5cm
REMARK : 50°C to 300°C



**X-197-01 2237-04 ESPRESSO MILK FROTHING THERMOMETER – SIZE : 7.5cm x 39.3cm
REMARK : 10°C to 285°C**



**X-197-02 2238-06 STEM TEST THERMOMETER – SIZE : 5.3cm x 20.8cm
REMARK : - 10°C to 100°C**



**X-197-03 322 CANDY / JELLY/ DEEP-FRY THERMOMETER – SIZE : 7.2cm x 15.3cm
REMARK : 90°C to 200°C**



**X-197-04 323 MEAT THERMOMETER – SIZE : 7.3cm x 15.4cm
REMARK : 54°C to 88°C**



**X-197-05 335 REFRIGERATOR / FREEZER THERMOMETER – SIZE : 12.7cm x 3cm
REMARK : -40°C to 25°C**



**X-197-06 25HP REFRIGERATOR / FREEZER THERMOMETER – SIZE : 5.8cm x 7.3cm
REMARK : -29°C to 27°C**



**X-197-07 WT-1 DIGITAL THERMOMETER
REMARK : -50°C to 300°C**



**X-197-08 3270-05-5 DEEP – FRY THERMOMETER – SIZE : 7.5cm x 39.3cm
REMARK: 10°C to 285°C**

BAR



ALUMINIUM BILL HOLDER



- **Y-199-01 BH-18** – SIZE : **L45cm x W6cm x H2cm** PACKING: **24PCS/CTN**
- **Y-199-02 BH-24** – SIZE : **L60cm x W6cm x H2cm** PACKING: **24PCS/CTN**
- **Y-199-03 BH-36** – SIZE : **L90cm x W6cm x H2cm** PACKING: **24PCS/CTN**

STAINLESS STEEL ROUND BILL SPIKE & SPINDLE BILL HOLDER



Y-199-04 B1913 STAINLESS STEEL ROUND BILL SPIKE –
SIZE : **D 75mm x H 115mm**
PACKING : **20 PACK X 20 UNIT**

Y-199-05 SBH-15 S/STEEL SPINDLE BILL HOLDER

SIZE: **H 15 cm**

It is ideal for holding memo, bills, receipts, and small notes, where we can easily keep track of nightly receipts. Featuring stainless steel body finishing, this bill holder can be assured to be durable and rust proof. With a heavy round base too, it is easy to stand on the

CALL BELL



Y-199-06 CHCC001 CALL BELL

SIZE: **D 8.5 cm**

Call bell offers a clear tone for announcing a customer in need and brushed nickel finish for a professional look.



JD-BMQ SERVICE MAT



Y-200-01 JD-BMQ SERVICE MAT

SIZE : L 45 cm x W 30 cm x H 1 cm

Service Mat JD-BMQ, a piece of rectangular rubber mat that is use to protect bar counter or countertop surface and soak up split drinks to reduce the messes. It's perfect for commercial bars and restaurants but also great to use at home. The soft but durable rubber mat and porous design helps to grip on wet glasses and dishes while also allowing them to dry quicker. It is a safer and more reliable soft surface to be included in your kitchen or bar.

Features:

1. Slip Prevention Texture

The bristled surface help to avoid slipping and keep sanitary while serving drinks or drying dishes. It allows air flow underneath efficiently air drying, also helps holding accidental spills and splashes.

2. Protection

It helps to protect glasses from scratches, broken rim and also prevent water stains on bar or countertop surface.

3. Easy to Clean

Just simply soak or wash with dishwashing detergent and rinse through.

Care and Use:

- Do not use abrasive utensils or knife on the product surface.
- Hand washing is recommended to keep this product in pristine shape and condition.
- Make sure this product is dry before storing.
- Do not place hot items such as pots and pans on the product.
- Keep away from extreme temperature and avoid exposure direct sunlight for longer lifespan.

JD-BMT BAR MAT

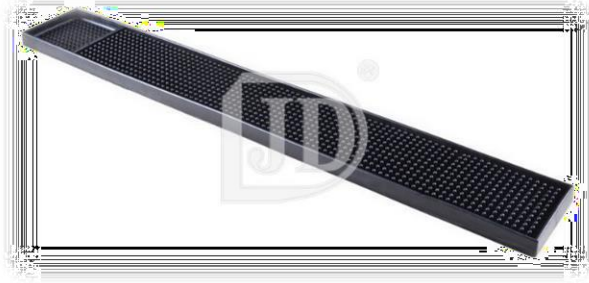

Y-201-01 JD-BMT BAR MAT

SIZE : L 60.5 cm x W 8.5 cm x H 1.5 cm

Bar Mat JD-BMT, a piece of practical long size rubber mat are perfect size for keeping shakers, mixing glasses and others tools sanitary while also keeps bar counter clean and dry. Bar mat have drainage area for jigger and the main area can holds up to six glasses. It's perfect for commercial bars and restaurants but also great to use at home. The soft but durable rubber mat and porous design helps to grip on wet glasses and bar tools allowing them to dry quicker. It is a safer and more reliable soft surface to be included in your kitchen or bar.

Features:

1. Slip Prevention Texture

The bristled surface help to avoid slipping and keep sanitary while serving drinks or drying dishes. It allows air flow underneath efficiently air drying, also helps holding accidental spills and splashes.

2. Protection

It helps to protect glasses from scratches, broken rim and also prevent water stains on bar or countertop surface.

3. Easy to Clean

Just simply soak or wash with dishwashing detergent and rinse through.

Care and Use:

- Do not use abrasive utensils or knife on the product surface.
- Hand washing is recommended to keep this product in pristine shape and condition.
- Make sure this product is dry before storing.
- Do not place hot items such as pots and pans on the product.
- Keep away from extreme temperature and avoid exposure direct sunlight for longer lifespan.

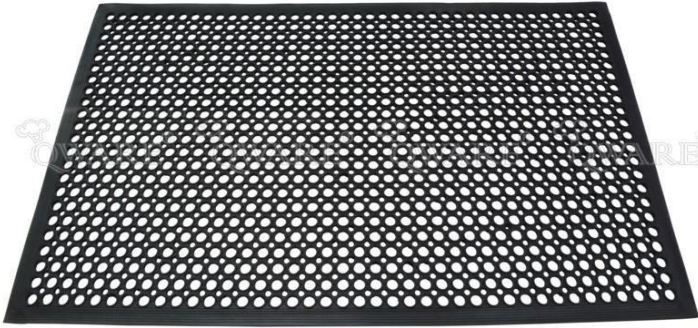

Y-202-01 QFM35 5' x 3' BAR FLOOR MAT

SIZE : L 150 cm x W 90 cm

WEIGHT : ± 7.7 KG

COLOR : Black

Wet floor or slippery are among the leading reason for falling accidents. Having a piece of anti-slip floor mat set in place, especially in an area prone to wet conditions such as kitchen and bar areas is essential. This QFM35 Bar Floor Mat it's perfect to use at wet and dry area but not limited to commercial kitchen, restaurant, bar, cafeteria and etc. The anti-fatigue mat and drainage design allow grime and liquids to flow through mat and help keep standing surface safe and dry.

Features:

1. Enhance Stability

Durable and heavy-duty design makes cleaning and moving the mat easily. It can be rolled up for storage or to make cleaning simple.

2. Slip Resistance

This effectively eradicates any potential slip hazard, while its slip prevention texture ensures the rubber mats stay in place and the textures surface of the rubber mat provides a safe non-slip surface to walk on.

3. Beveled Edges

The rumpled edges of the rubber mat enable trolleys and cages to be easily transported over the mats and to prevent tripping hazard which suitability to place in high traffic areas.

4. Drainage Design

The construction of the rubber mat allow grime and liquids to flow through mat and help keep the standing surface safe and dry.

5. Anti-fatigue

The thick rubber mat provides outstanding comfort and feet support for prolonged periods of standing on working platform.

Care and Use:

- Keep away from extreme temperature and avoid exposure direct sunlight for longer lifespan.
- Cleaning this product regularly with mild detergent and water to remove dirt to keep it hygiene.
- Make sure this product is dry before storing.

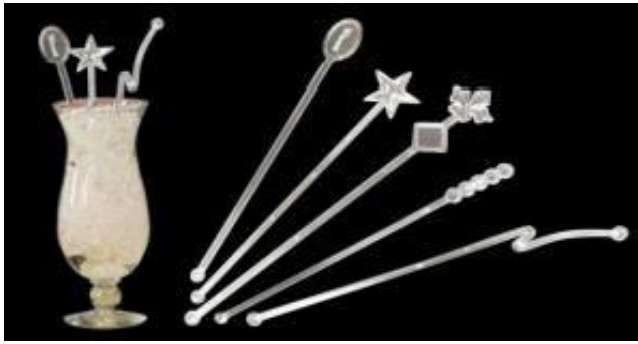

Y-203-01 PSS 100187 PLASTIC STIRING STICK (EGG/STAR/DOT/FLOWER/HOOK) – SIZE : **L210mm** PACKING : **100PKT/CTN**



- **Y-203-02** PSS-B 101985 BLACK PLASTIC STIRING STICK – SIZE : **L198mm** PACKING : **100PKT/CTN**
- **Y-203-03** PSS 102448 CLEAR PLASTIC STIRING STICK – SIZE : **L198mm** PACKING : **100PKT/CTN**

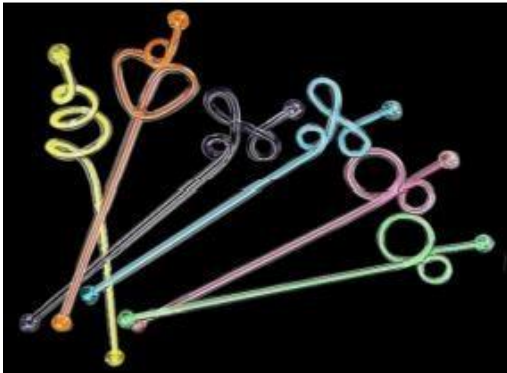

Y-203-04 JD-002 101543 ACRYLIC SWIZZLE STICK STIRRER – SIZE : **L230mm** PACKING : **100PKT/CTN**



Y-203-05 JD-003 102214 ACRYLIC SWIZZLE STICK STIRRER – SIZE : **L280mm** PACKING : **100PKT/CTN**



Y-203-06 SR-06 101689 6 HOLE SQUARE ACRYLIC SHOOTER RACK – SIZE : **L115mm x W170mm x H90mm** PACKING : **24PCS**

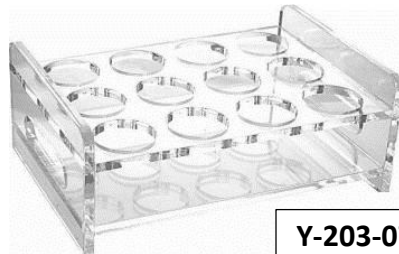

Y-203-07 SR-1234 101655 12 HOLE SQUARE ACRYLIC SHOOTER RACK – SIZE : **L225mm x W150mm x H90mm** PACKING : **24PCS**



Y-203-08 SR-B06 102018 6 HOLE DELUXE ACRYLIC SHOOTER RACK – SIZE : **L200mm x W125mm x H65mm** PACKING : **24PCS**



Y-203-09 SR-B1234 102019 12 HOLE DELUXE ACRYLIC SHOOTER RACK – SIZE : **L265mm x W170mm x H55mm** PACKING : **24PCS**



Y-204-01 SODA SIPHON – SIZE : D 9.5 x 26.5 cm



Y-204-02 10'S MOSA SODA CHARGERS



Y-204-03 CREAM WHIPPER – SIZE : D 8 x 20.5 cm



Y-204-04 10'S MOSA CREAM CHARGERS



- **Y-204-05 FM23 RUBBER FLOOR MAT**
SIZE : L 2 FT x 3 FT
PACKING: 6 PCS/CTN
- **Y-204-06 FM35 RUBBER FLOOR MAT**
SIZE : L 3 FT x 5 FT
PACKING: 1 PCS/CTN



Y-204-07 3549 SEA HORSE DESIGN S/STEEL CORKSCREWS
PACKING : 480PCS/CTN

MAGNETIC KNIFE HOLDER

- **Y-205-01 MKH-38 – SIZE : 38cm**
PACKING : 60 PCS/CTN
- **Y-205-02 MKH-50 – SIZE : 50cm**
PACKING : 60 PCS/CTN



STAINLESS STEEL LIME AND LEMON PRESS



Y-205-03 STAINLESS STEEL LIME AND LEMON PRESS
SIZE : L 8 cm x W 6.5 cm

The lime and lemon press are perfect for making individual drinks. Featuring hand press style, just apply gentle pressure and juice will come out handy pour spout.

STAINLESS STEEL LEMON SQUEEZER



Y-205-04 STAINLESS STEEL LEMON SQUEEZER
SIZE : D 6.6 cm x L 20.5 cm

Enjoy fresh-squeezed lemon juice without electricity, batteries, or hard-to-operate juice squeezers. Its extra-long handle designed for extra leverage.





**Y-206-01 A612 ALUMINIUM
JUICER PRESS –
SIZE : D 9.8cm x H11cm x L25 cm**



**Y-206-02 BS1511-SS
STAINLESS STEEL BAR
STRAINER –
SIZE : L 15.2cm x W11cm**



**Y-206-03 CH-4509-BK BILL FOLDER
(BLACK) –
SIZE: L22.5cm x W11 cm**



**Y-206-04 JD-8700A PC BOSTON
SHAKER –
SIZE : D 9.5cm x H 24.5cm**

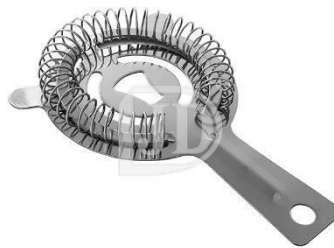

**Y-206-05 JD-891 BAR
STRAINER WITH FLAT
HANDLE –
SIZE : L 14.3cm x W 9cm**



**Y-206-06 JD-B4B 4
COMPARTMENT CONDIMENT
HOLDER –
SIZE : L 50cm x W 16cm x H 9cm**



**Y-206-07 JD-B5B 5
COMPARTMENT CONDIMENT
HOLDER –
SIZE : L 50cm x W 16cm x H 9cm**



**Y-206-08 JD-B6B 6
COMPARTMENT CONDIMENT
HOLDER –
SIZE : L 50cm x W 16cm x H 9cm**



**Y-206-09 JD-BC BAR CADDY –
SIZE : L 24cm x W 15cm x H 10.5cm**



Y-207-01 JD-BP CHROMED METAL FREE POURER – SIZE : L 10.5cm



Y-207-02 FP5S S/STEEL FREE POURER – PACKING : 12PCS/PCK



Y-207-03 JD-BR ECONOMY FREE POURER – SIZE : L 6.5cm



Y-207-04 JD-BSS SALT & SUGAR GLASS RIMMER – SIZE : L 20cm x W 16cm x H 7cm



Y-207-05 SSD4 SMALL HOLE STRAW DISPENSER – SIZE : L 23.5cm x W 11.5cm x H 19cm



Y-207-06 CIB8020 CRYSTAL ICE BUCKET – SIZE : 12cm x H 12.5cm PACKING : 36 PCS/CTN



Y-207-07 CBS1962 LUXURY S/STEEL CHAMPAGNE BUCKET STAND – SIZE : 19cm x H 61cm PACKING : 6PCS/CTN



Y-207-08 CB19522 LUXURY S/STEEL CHAMPAGNE BUCKET – SIZE : 19cm x H 22cm PACKING : 30PCS/CTN



Y-207-09 95190 S/STEEL STIRRER – SIZE : 22cm PACKING : 600 PCS/CTN

STAINLESS STEEL BAR SPOON



- **Y-208-01** BS-9 10" – SIZE : L 25.4 cm
- **Y-208-02** BS-12 12.5" – SIZE : L 32 cm

This bar spoon can use to stir, mix, and muddle, gig cherries and olives. Easily scoop condiments out of large jars, stir drinks in deep tumblers or layer shots into drinks. Using its back side you can also create colorful shots or rainbows as well.

STAINLESS STEEL COCKTAIL SHAKER



- **Y-208-03** CS-350 – SIZE : H 17cm Capacity: 350 ml
- **Y-208-04** CS-530 – SIZE : H 21.5 cm Capacity : 530 ml
- **Y-208-05** CS-750 – SIZE : H 23.5 cm Capacity : 750 ml

This is a very elegant looking cocktail shaker made by stainless steel. Because of the stainless-steel material, this cocktail shaker is very easy to clean and it will never rust.

PC COCKTAIL SHAKER



- **Y-208-06** JD-8350P – SIZE : Ø 8 cm x H 17 cm
Capacity : 350 ml
- **Y-208-07** JD-8530P – SIZE : Ø 8.5 cm x H 20 cm
Capacity : 530 ml
- **Y-208-08** JD-8700P – SIZE : Ø 8.5 cm x H 22 cm
Capacity : 700 ml
- **Y-208-09** JD-8100P – SIZE : Ø 9 x H 28.5 cm
Capacity : 1000ml

PC DOUBLE JIGGER MEASURING CUP



- **Y-209-01** JD-8616 – SIZE : H 11 cm Capacity: **20/40 cc**
- **Y-209-02** JD-8617 – SIZE : H 9 cm Capacity : **530 ml**

S/STEEL JINGGER ME



- **Y-209-03** W0530A – Capacity : **20/30 cc**
PACKING : **144 PCS/CTN**
- **Y-209-04** W0540A – Capacity : **20/40 cc**
PACKING : **144 PCS/CTN**
- **Y-209-05** W0550A – Capacity : **25/50 cc**
PACKING : **144 PCS/CTN**

MEASURING CUP



Y-209-06 JD8660 MEASURING CUP –

SIZE : TD 9 cm x BD 6 cm x H 15 cm

Capacity : **400 ml**

Remark : Can be paired and used along with JD-BSK
STAINLESS STEEL BOSTON SHAKER

This useful, multi-purpose measuring cup combines quality and the most common household measurements into one utensil, making it an invaluable addition to your home. In order to correctly prepare your dishes, measuring cup are a vital instrument in the kitchen. Use it for cooking ingredients, mixed drinks, detergents, medications, gardening liquids, diet drinks and more.

S/STEEL COCKTAIL MUDDLER



- **Y-210-01** AGM6738 – SIZE : **20cm**
PACKING : **200 PCS/CTN**
- **Y-210-02** AGM23 – SIZE : **23cm**
PACKING : **200 PCS/CTN**
- **Y-210-03** AGM243 – SIZE : **24.3cm**
PACKING : **200 PCS/CTN**
- **Y-210-04** AGM295 – SIZE : **2cm**
PACKING : **200 PCS/CTN**

STORER 'N POUR



- **Y-210-05** JD-BSP1 – SIZE : **D 9cm x H 33cm**
Capacity : **1 L**
- **Y-210-06** JD-BSP2 – SIZE : **D 12 cm x H 35 cm**
Capacity : **2 L**
- **Y-210-07** JD-BSP25 – SIZE : **D 12.5 cm x H 38 cm**
Capacity : **2.5 L**

STAINLESS STEEL BOSTON SHAKER



- Y-210-08** JD-BSK STAINLESS STEEL BOSTON SHAKER
SIZE : **TD 9.3cm x BD 6cm x H 17cm**
Remark : Can be paired and used along with JD8660 MEASURE CUP

FIBERGLASS NON-SLIP SERVING TRAY

ROUND SHAPE

- Y-211-01 FG-1400CT – SIZE : 14" PACKING : 12 PCS/CTN
- Y-211-02 FG-1600CT – SIZE : 16" PACKING : 12 PCS/CTN
- Y-211-03 FG-1800CT – SIZE : 18" PACKING : 12 PCS/CTN

OVAL SHAPE

- Y-211-04 FG-2700CT – SIZE : 27" PACKING : 6 PCS/CTN
- Y-211-05 FG-2900CT – SIZE : 29" PACKING : 6 PCS/CTN

RECTANGULAR SHAPE

- Y-211-06 FG-1216CT – SIZE : 12" x 16" PACKING : 12 PCS/CTN
- Y-211-07 FG-1418CT – SIZE : 14" x 18" PACKING : 12 PCS/CTN
- Y-211-08 FG-1520CT – SIZE : 15" x 20" PACKING : 12 PCS/CTN
- Y-211-09 FG-1622CT – SIZE : 16" x 22" PACKING : 12 PCS/CTN



OPTIONAL ACCESSORIES FOR FIBERGLASS NON-SLIP SERVING TRAY

Y-212-01 GX056A S/STEEL DUMMY STAND

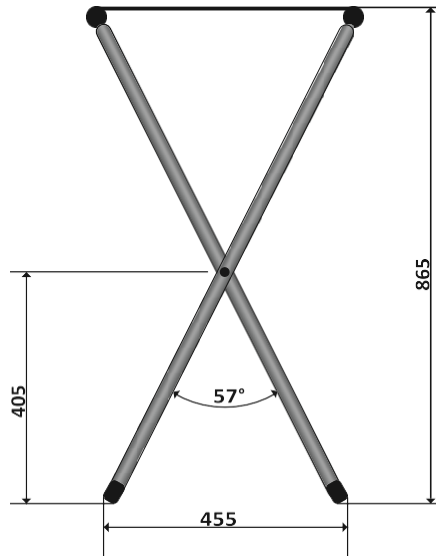
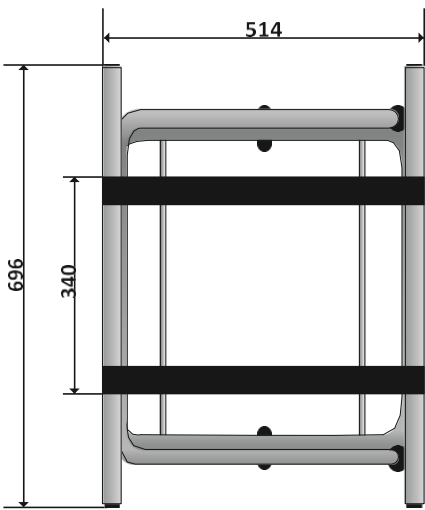

HDPE CUTTING BOARD



- **Y-213-01 CB-30402 –**
SIZE : L 30cm x W 40cm x H 2cm
- **Y-213-02 CB-30452 –**
SIZE : L 30cm x W 45cm x H 2cm
- **Y-213-03 CB-35502 –**
SIZE : L 35cm x W 50cm x H 2cm
- **Y-213-04 CB-40602 –**
SIZE : L 40cm x W 60cm x H 2cm

HDPE ROUND CUTTING BOARD



- **Y-213-01 RCB-253 –** SIZE : 25cm x 3cm
- **Y-213-02 RCB-255 –** SIZE : 25cm x 5cm
- **Y-213-03 RCB-303 –** SIZE : 30cm x 3cm
- **Y-213-04 RCB-305 –** SIZE : 30cm x 5cm
- **Y-213-05 RCB-353 –** SIZE : 35cm x 3cm
- **Y-213-06 RCB-355 –** SIZE : 35cm x 5cm
- **Y-213-07 RCB-403 –** SIZE : 40cm x 3cm
- **Y-213-08 RCB-405 –** SIZE : 40cm x 5cm
- **Y-213-09 RCB-4010 –** SIZE : 40cm x 10cm
- **Y-213-10 RCB-455 –** SIZE : 45cm x 5cm
- **Y-213-11 RCB-4510 –** SIZE : 45cm x 10cm
- **Y-213-12 RCB-505 –** SIZE : 50cm x 5cm
- **Y-213-13 RCB-5010 –** SIZE : 50cm x 10cm

OPTIONAL ACCESSORIES FOR HDPE CUTTING BOARD

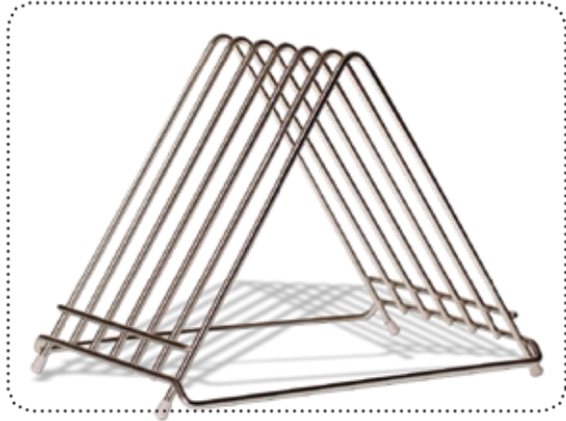

Y-214-01 CBH-A 6 PIECES S/STEEL CUTTING BOARD HOLDER – SIZE : 6mm



- **Y-214-02** CBS16 S/STEEL CUTTING BOARD STAND – SIZE: 16' x H 69cm
- **Y-214-03** CBS18 S/STEEL CUTTING BOARD STAND – SIZE: 18' x H 69cm

TRANSPARENT PC ICE SCOOP



- **Y-214-04** 8227 –
SIZE : (S) L 23cm x W 6cm x H 5cm
PACKING : 144PCS/CTN
- **Y-214-05** 8226 –
SIZE : (M) L 26cm x W 7cm x H 6cm
PACKING : 144PCS/CTN
- **Y-214-06** 8225 –
SIZE : (L) L 31cm x W 10cm x H 7cm
PACKING : 144PCS/CTN
- **Y-214-07** 8225A –
SIZE : (XL) L 34cm x W 12cm x H 7cm
PACKING : 144PCS/CTN

18.8 S/STEEL ICE SCOOP



- **Y-215-01 ICP4** – Capacity : **6 oz**
PACKING : **120PCS/CTN**
- **Y-215-02 ICP3** – Capacity : **12 oz**
PACKING : **120PCS/CTN**
- **Y-215-03 ICP2** – Capacity : **24 oz**
PACKING : **120PCS/CTN**
- **Y-215-04 ICP1** – Capacity : **36 oz**
PACKING : **120PCS/CTN**

ALLUMINIUM ICE SCOOP



- **Y-215-05 AICP4** – Capacity : **6 oz**
PACKING : **200PCS/CTN**
- **Y-215-06 AICP3** – Capacity : **12 oz**
PACKING : **200PCS/CTN**
- **Y-215-07 AICP2** – Capacity : **24 oz**
PACKING : **120PCS/CTN**
- **Y-215-08 AICP1** – Capacity : **36 oz**
PACKING : **100PCS/CTN**

POLISHED ALUMINIUM ICE CREAM SCOOP



Y-215-09 ICSP – SIZE : **18cm**
PACKING : **100PCS/CTN**

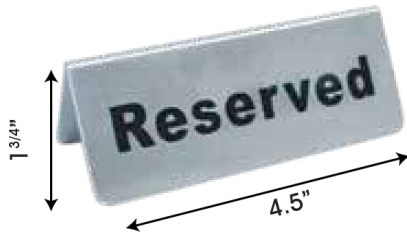

**Y-216-01 SARS-450 A SHAPE S/STEEL RESERVED TABLE TENTS – SIZE : 4.5”
PACKING : 15PCS/CTN**



**Y-216-02 MPH03 S/STEEL MULTIPURPOSE CLIP –
SIZE : 23.5cm x 4.3cm
PACKING : 100PCS/CTN**

S/STEEL MENU STAND



- **Y-216-03 SMS 2 S/STEEL MENU STAND – SIZE : 2”
PACKING : 100PCS/CTN**
- **Y-216-04 SMS 8 S/STEEL MENU STAND – SIZE : 8”
PACKING : 100PCS/CTN**
- **Y-216-05 SMS 12 S/STEEL MENU STAND – SIZE : 12”
PACKING : 100PCS/CTN**
- **Y-216-06 SMS 14 S/STEEL MENU STAND – SIZE : 14”
PACKING : 100PCS/CTN**
- **Y-216-07 SMS 16 S/STEEL MENU STAND – SIZE : 16”
PACKING : 100PCS/CTN**
- **Y-216-08 SMS 18 S/STEEL MENU STAND – SIZE : 18”
PACKING : 100PCS/CTN**

4 CASE PLASTIC CUP HOLDER

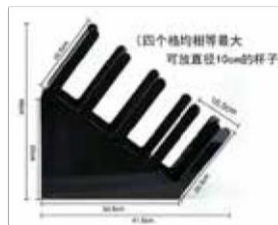

- **Y-216-09 PCH-4B 4 CASE PLASTIC CUP HOLDER – SIZE : 41.5cm x H 46cm
PACKING : 6PCS/CTN**
- **Y-216-10 PCH-4G 4 CASE PLASTIC CUP HOLDER – SIZE : 41.5cm x H 46cm
PACKING : 6PCS/CTN**
- **Y-216-11 PCH-4R 4 CASE PLASTIC CUP HOLDER – SIZE : 41.5cm x H 46cm
PACKING : 6PCS/CTN**
- **Y-216-12 PCH-4BW 4 CASE PLASTIC CUP HOLDER – SIZE : 41.5cm x H 46cm
PACKING : 6PCS/CTN**

JAPANESE BENTO BOX



- **Y-217-01 YK-602** – SIZE : L 26cm x W 20.5cm x H 5cm
PACKING : 20PCS/CTN
- **Y-217-02 YK-601** – SIZE : L 30cm x W 23.5cm x H 5cm
PACKING : 20PCS/CTN

S/STEEL SQUARE TRAY SET

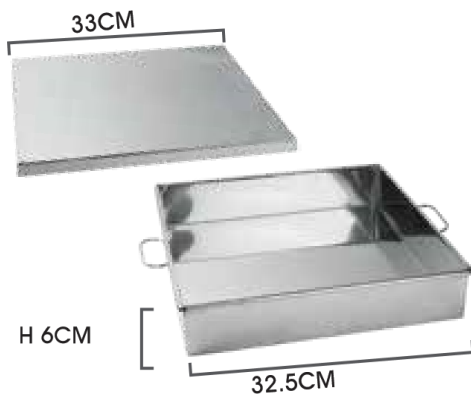

- **Y-217-03 0509A/C** – SIZE : L 33cm x W 32.5cm x H 6cm
PACKING : 28PCS/CTN

SILICONE SCRAPER

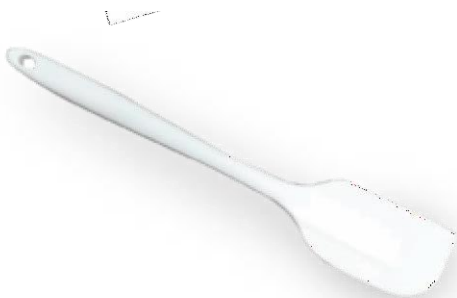

Q-UP STAND



Y-218-01 SW-SRS 155 S/STEEL SELF RETRACTABLE
Q-UP STAND – SIZE : **1.7M**
PACKING: **1 PCS/CTN**

COLOUR:

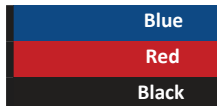

Blue

Red

Black

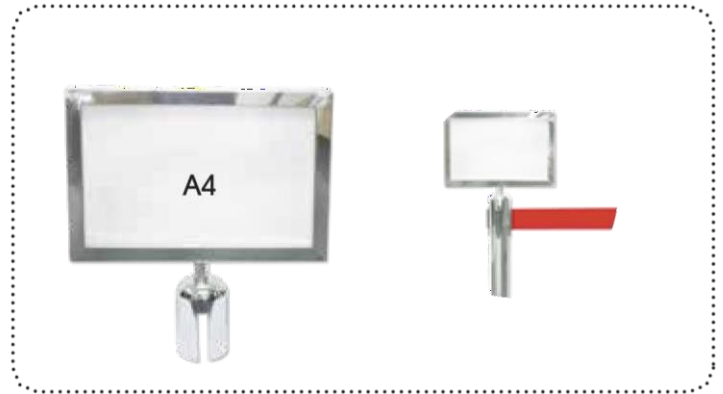

Y-218-02 A4 SIZE S/STEEL RAILING SIGN –
SIZE : **A4**
PACKING: **1 PCS/CTN**

MISCELLANEOUS PRODUCTS



Z-219-01 RA-WD-SZ-917 917 SIZZLING PLATE –
SIZE : 12" PACKING : 12 SET/CTN



Z-219-02 WIRE BBQ BRUSH WITH
SCRAPER – SIZE : L 45.5 cm

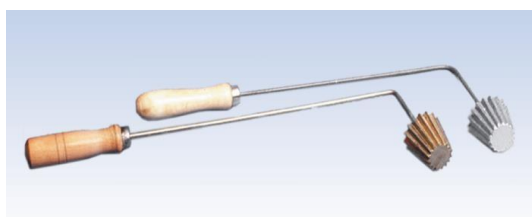

- **Z-219-03** B-PT PAITI ALUMINIUM
- **Z-219-04** T-PT PAITI COPPER



- **Z-219-05** RA-KT-SB-P03 SCRAPER P.HANDLE – SIZE : 3"
- **Z-219-06** RA-KT-SB-P04 SCRAPER P.HANDLE – SIZE : 4"
- **Z-219-07** RA-KT-SB-P05 SCRAPER P.HANDLE – SIZE : 5"
- **Z-219-08** RA-KT-SB-P06 SCRAPER P.HANDLE – SIZE : 6"

MEASURING CUP



- **Z-220-01** JD-PC8596 – SIZE : D 14.5cm x H 15.5cm
Capacity : **500ml**
- **Z-220-02** JD-PC8597 – SIZE : D 18cm x H 19cm
Capacity : **1000ml**
- **Z-220-03** JD-PC8598 – SIZE : D 21cm x H 23cm
Capacity : **2000ml**
- **Z-220-04** JD-PC8599 – SIZE : D 24cm x H 26cm
Capacity : **3000ml**
- **Z-220-05** JD-PC8600 – SIZE : D 26cm x H 30cm
Capacity : **5000ml**

K8240 SERIES PLASTIC MEASURING CUP



- **Z-220-06** K8241 – VOLUME : 250ml
PACKING : **12 PACK X 12 UNIT**
- **Z-220-07** K8242 – VOLUME : 500ml
PACKING : **12 PACK X 12 UNIT**
- **Z-220-08** K8243 – VOLUME : 1000ml
PACKING : **8 PACK X 12 UNIT**
- **Z-220-09** K8244 – VOLUME : 2000ml
PACKING : **4 PACK X 12 UNIT**
- **Z-220-10** K8245 – VOLUME : 3000ml
PACKING : **4 PACK X 12 UNIT**
- **Z-220-11** K8246 – VOLUME : 5000ml
PACKING : **2 PACK X 12 UNIT**



Z-220-12 B7618 PC WATER
PITCHER –
VOLUME : **1800ml**
PACKING : **2 PACK X 12 UNIT**



Z-220-13 82686W PC SALAD
BOWL –
SIZE: **D 17"**



Z-221-01 JD-PWD PLASTIC WRAP DISPENSER –

SIZE : L 56 cm x W 20 cm x H 17.5 cm

Plastic Wrap Dispenser reduces the risk of contamination from unsanitary cutter on the box or uncovered plastic wrap in the kitchen. It is suitable for institutional size rolls of foodservice 12-18 inch rolls of film and aluminum foil up to 3000 feet long.



- **Z-221-02 HL-S-9096**
STANDARD – Capacity : **940ML**
- **Z-221-03 HL-S-9096TR**
STANDARD – Capacity : **940ML**



- **Z-221-04 SF-1040 SQUEEZE BOTTLE W/LIP** – Capacity : **8 Oz**
PACKING : **100PCS/CTN**
- **Z-221-05 SF-1041 SQUEEZE BOTTLE W/LIP** – Capacity : **12 Oz**
PACKING : **100PCS/CTN**
- **Z-221-06 SF-1042 SQUEEZE BOTTLE W/LIP** – Capacity : **16 Oz**
PACKING : **100PCS/CTN**
- **Z-221-07 SF-1043 SQUEEZE BOTTLE W/LIP** – Capacity : **24 Oz**
PACKING : **100PCS/CTN**



洋葱器
Onion Slicer



Z-221-08 K0010 SERIES ONION SLICER –
PACKING : **48 PCS/CTN**

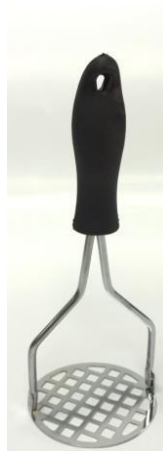

Z-221-09 RA-KT-PM-01
POTATO MASHER –
SIZE : **10"**



Z-221-10 ZB-SC-
199927 STEEL
CLEANER –
Capacity : **270G**



**Z-222-01 413PS SPAGHETTI SERVER –
SIZE : L 39 cm**

Easy to hold, special prongs allow you to easily catch even the most slippery pasta. The holes in the spoon help you drain excess water from pasta and eliminate watery sauces. It also features a hooked handle for easy hanging.



**Z-222-02 S-703C MULTI PURPOSE
CLAMP – SIZE : L 18 cm**



**Z-222-03 PVS GAS CYLINDER HOLDER –
SIZE : D 34cm x H 9cm**

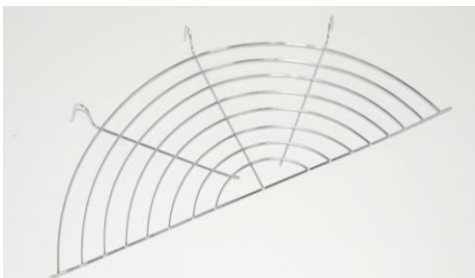

- **Z-222-04 EL-A-14 SEMI CIRCLE STAND –
SIZE : 14"**
- **Z-222-05 EL-A-15 SEMI CIRCLE STAND –
SIZE : 15"**
- **Z-222-06 EL-A-16 SEMI CIRCLE STAND –
SIZE : 16"**



- **Z-222-07 HL-PT-B-524 THAI PLASTIC BRUSH**
- **Z-222-08 HL-PT-B-525 THAI PLASTIC BRUSH**
- **Z-222-09 HL-PT-B-1526 THAI PLASTIC**



- **Z-222-10 003 4.5" RAYACO
TOILET PUMP – HANDLE :
1.3P / 2.5R / 4R
PACKING :
1DZS/BOX;12DZS/CTN**
- **Z-222-11 002 5.5" RAYACO
TOILET PUMP – HANDLE :
1.3P / 2.5R / 4R
PACKING :
1DZS/BOX;12DZS/CTN**



- **Z-222-12 NO.1 GLASS BRUSH –
SIZE : 27cm x 19 cm x 10 cm**
- **Z-222-13 NO.2 GLASS BRUSH –
SIZE : 20cm x 19cm x 10cm**



- **Z-223-01** NS-I-1 NO.1 SCALE REMOVER
- **Z-223-02** NS-I-2 NO.2 SCALE REMOVER



- BONHEAT WAX FUEL (COOKING FUEL) TIN – Capacity :**
- **Z-223-03** 250ml
 - **Z-223-04** 1 liter
- BONHEAT WAX FUEL (COOKING FUEL) TIN – WEIGHT :**
- **Z-223-05** 3KG
 - **Z-223-06** 14KG



- **Z-223-07** NS-K-CNA1-1 COPPER NYLON – SIZE : 5.5"
- **Z-223-08** NS-K-CNA COPPER NYLON – SIZE : 5"



- **Z-223-09** NS-K-NA NYLON STRAINER – SIZE : 5"
- **Z-223-10** NS-K-A COLTH STRAINER – SIZE : 5"



Z-223-11 NS-K-NAXL NYLON STRAINER – SIZE : 10"



Z-223-12 E5018 JAPAN OIL BRUSH WITH WOODEN HANDLE – SIZE : D 9cm

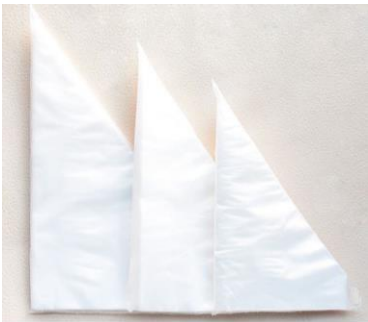

- 100 PCS PIPING BAG**
- **Z-223-13** SN-5012 -SIZE : 12"
 - **Z-223-14** SN-5014 -SIZE : 14"
 - **Z-223-15** SN-5016 - SIZE : 16"



L0151 SERIES MICROFIBER TOWEL



超细纤维毛巾
Microfiber Towel



- **Z-225-01** L0151-01 **RED** MICROFIBER TOWEL – SIZE : **L 400mm x W 300mm**
WEIGHT : **32g** PACKING : **25 PACK X 24 UNIT**
- **Z-225-02** L0151-02 **YELLOW** MICROFIBER TOWEL – SIZE : **L 400mm x W 300mm**
WEIGHT : **32g** PACKING : **25 PACK X 24 UNIT**
- **Z-225-03** L0151-05 **BROWN** MICROFIBER TOWEL – SIZE : **L 400mm x W 300mm**
WEIGHT : **32g** PACKING : **25 PACK X 24 UNIT**
- **Z-225-04** L0151-07 **GRAY** MICROFIBER TOWEL – SIZE : **L 400mm x W 300mm**
WEIGHT : **32g** PACKING : **25 PACK X 24 UNIT**
- **Z-225-05** L0151-11 **WHITE** MICROFIBER TOWEL – SIZE : **L 400mm x W 300mm**
WEIGHT : **32g** PACKING : **25 PACK X 24 UNIT**
- **Z-225-06** L0151-19 **DARK BLUE** MICROFIBER TOWEL – SIZE : **L 400mm x W 300mm**
WEIGHT : **32g** PACKING : **25 PACK X 24 UNIT**



Z-225-07 EZ-MF- 3575-1 MICRO 1 LAYER –
SIZE : **35 x 75CM**

L0153 SERIES MICROFIBER TOWEL



超细纤维毛巾
Microfiber Towel



*12 pcs per pack per colour

- **Z-226-01** L0153-01 **RED** MICROFIBER TOWEL – SIZE : **L 750mm x W 350mm**
WEIGHT : **68g** PACKING : **50 PACK X 12 UNIT**
- **Z-226-02** L0153-02 **YELLOW** MICROFIBER TOWEL – SIZE : **L 750mm x W 350mm**
WEIGHT : **68g** PACKING : **50 PACK X 12 UNIT**
- **Z-226-03** L0153-03 **GREEN** MICROFIBER TOWEL – SIZE : **L 750mm x W 350mm**
WEIGHT : **68g** PACKING : **50 PACK X 12 UNIT**
- **Z-226-04** L0153-04 **BLUE** MICROFIBER TOWEL – SIZE : **L 750mm x W 350mm**
WEIGHT : **68g** PACKING : **50 PACK X 12 UNIT**
- **Z-226-05** L0153-05 **BROWN** MICROFIBER TOWEL – SIZE : **L 750mm x W 350mm**
WEIGHT : **68g** PACKING : **50 PACK X 12 UNIT**
- **Z-226-06** L0153-06 **PURPLE** MICROFIBER TOWEL – SIZE : **L 750mm x W 350mm**
WEIGHT : **68g** PACKING : **50 PACK X 12 UNIT**
- **Z-226-07** L0153-07 **GRAY** MICROFIBER TOWEL – SIZE : **L 750mm x W 350mm**
WEIGHT : **68g** PACKING : **50 PACK X 12 UNIT**
- **Z-226-08** L0153-11 **WHITE** MICROFIBER TOWEL – SIZE : **L 750mm x W 350mm**
WEIGHT : **68g** PACKING : **50 PACK X 12 UNIT**

L0127 SERIES

早安毛巾
Good Morning Towel



Z-226-09 L0127 GOOD MORNING TOWEL – SIZE : **L 700mm x W 320mm** WEIGHT : **70 g**
PACKING : **50 PACK X 12 UNIT**

1 - 8 GALLON PLASTIC PAIL/BUCKET



3.79 litre - 30.28 litre
1gallon -- 8gallon Baldi / Pail

- **Z-227-01** 1 GALLON PLASTIC PAIL – SIZE : Ø200mm x D150mm
- **Z-227-02** 2 GALLON PLASTIC PAIL – SIZE : Ø280mm x D230mm
- **Z-227-03** 3 GALLON PLASTIC PAIL – SIZE : Ø310mm x D260mm
- **Z-227-04** 4 GALLON PLASTIC PAIL – SIZE : Ø320mm x D290mm
- **Z-227-05** 5 GALLON PLASTIC PAIL – SIZE : Ø335mm x D320mm
- **Z-227-06** 6 GALLON PLASTIC PAIL – SIZE : Ø350mm x D350mm
- **Z-227-07** 8 GALLON PLASTIC PAIL – SIZE : Ø400mm x D430mm

PLASTIC BASIN



COLOUR:



- **Z-227-08** 6070 PLASTIC BASIN – SIZE : 7" PACKING : 24DZS/CTN
- **Z-227-09** 6085 PLASTIC BASIN – SIZE : 8.5" PACKING : 24DZS/CTN
- **Z-227-10** 6100 PLASTIC BASIN – SIZE : 10" PACKING : 24DZS/CTN
- **Z-227-11** 6120 PLASTIC BASIN – SIZE : 12" PACKING : 12DZS/CTN
- **Z-227-12** 6140 PLASTIC BASIN – SIZE : 14" PACKING : 8DZS/CTN
- **Z-227-13** 6160 PLASTIC BASIN – SIZE : 16" PACKING : 6DZS/CTN
- **Z-227-14** 6180 PLASTIC BASIN – SIZE : 18" PACKING : 48DZS/CTN
- **Z-227-15** 6200 PLASTIC BASIN – SIZE : 20" PACKING : 36DZS/CTN

TOYOGO NESTABLE CONTAINER CUTLERY STORAGE



- **Z-228-01 3904** – Capacity : **17 L** PACKING : **2 UNITS/BUNDLE**
- **Z-228-02 3905** – Capacity : **25 L** PACKING : **2 UNITS/BUNDLE**
- **Z-228-03 3906** – Capacity : **44 L** PACKING : **2 UNITS/BUNDLE**

WATER JUG



Z-228-04 237 TOYOGO WATER JUG –
SIZE : **D160mm (6.3") X H 260mm (10.2")**
Capacity : **4 L**
PACKING : **1 UNIT/BUNDLE**



Z-228-05 236 TOYOGO WATER JUG –
SIZE : **L 13cm x W 13cm x H 23cm**
Capacity : **2.2 L**
PACKING : **6 PACK**

MULTIPURPOSE CONTAINER



- **Z-229-01** NCI 6710 –
SIZE : 260mm x 195mm x 65mm
- **Z-229-02** NCI 6712 –
SIZE : 310mm x 245mm x 75mm
- **Z-229-03** NCI 6714 –
SIZE : 355mm x 290mm x 95mm
- **Z-229-04** NCI 6716 –
SIZE : 405mm x 340mm x 110mm



- **Z-229-05** NCI 6810 –
SIZE : 270mm x 200mm x 110mm
- **Z-229-06** NCI 6812 –
SIZE : 320mm x 250mm x 130mm
- **Z-229-07** NCI 6814 –
SIZE : 370mm x 300mm x 150mm
- **Z-229-08** NCI 6816 –
SIZE : 420mm x 345mm x 170mm



- **Z-229-09** NCI 6910 –
SIZE : 260mm x 195mm x 165 mm
- **Z-229-10** NCI 6912 –
SIZE : 310mm x 245mm x 195 mm
- **Z-229-11** NCI 6914 –
SIZE : 355mm x 290mm x 225 mm
- **Z-229-12** NCI 6916 –
SIZE : 405mm x 340mm x 250 mm



COOLER BOX



- **Z-230-01** HL-S-M02 – Capacity : **2 L** PACKING : **12 SET**
- **Z-230-02** HL-S-M04 – Capacity : **4 L** PACKING : **12 SET**
- **Z-230-03** HL-S-M06 – Capacity : **6 L** PACKING : **12 SET**
- **Z-230-04** HL-S-M09 – Capacity : **9 L** PACKING : **12 SET**
- **Z-230-05** HL-S-M11 – Capacity : **11 L** PACKING : **6 SET**
- **Z-230-06** HL-S-M13 – Capacity : **13 L** PACKING : **6 SET**
- **Z-230-07** HL-S-M17 – Capacity : **17 L** PACKING : **4 SET**
- **Z-230-08** HL-S-M27 – Capacity : **27 L** PACKING : **1 SET**
- **Z-230-09** HL-S-M40 – Capacity : **40 L** PACKING : **1 SET**





Z-231-01 3M SCOTCH-BRITE GENERAL DUTY SCRUB SPONGE – SIZE : 10cm x 7.5cm x 3cm



Z-231-02 3M SCOTCH-BRITE ALL PURPOSE CLEANING NET SPONGE



Z-231-03 3M SCOTCH-BRITE METALLIC SPONGE



**Z-232-01 RAYACO ALUMINIUM
CLEANING BALL**



- **Z-232-02 NS-FN-R ROUND WASHER –
SIZE : 5"**
- **Z-232-03 NS-FN-4 SQUARE WASHER –
SIZE : 5" x 5"**
- **Z-232-04 NS-FN-XL ROUND WASHER –
SIZE : 6"**



**Z-232-05 HL-CS-MB-05 SCOURER –
SIZE : 150MM x 175MM**



COLLECTOR & SERVING TROLLEY

COLLECTOR TROLLEY



- **Z-234-01** GX-032C 3 TIER SQUARE TUBE PLASTIC SERVING TROLLEY (GREY) –
SIZE : 84.5cm x 43cm x 95cm
PACKING : 1PCS/CTN
- **Z-234-02** GX-032D 3 TIER SQUARE TUBE PLASTIC SERVING TROLLEY (GREY) –
SIZE : 95cm x 50cm x 96cm
PACKING : 1PCS/CTN



- **Z-234-03** GX-032C-B 3 TIER SQUARE TUBE PLASTIC SERVING TROLLEY (BLACK) –
SIZE : 84.5cm x 43cm x 95cm
PACKING : 1PCS/CTN
- **Z-234-04** GX-032D-B 3 TIER SQUARE TUBE PLASTIC SERVING TROLLEY (BLACK) –
SIZE : 95cm x 50cm x 96cm
PACKING : 1PCS/CTN



- **Z-234-05** 505C S/STEEL COLLECTOR TROLLEY – SIZE : 89cm x 44cm x 93cm
PACKING : 2 PCS/CTN
- **Z-234-06** A1061-2 S/STEEL COLLECTOR TROLLEY – SIZE : 95cm x 46cm x 93cm
PACKING : 2 PCS/CTN



- **Z-234-07** A1060-1 S/STEEL SQUARE TUBE COLLECTOR TROLLEY – SIZE : 89cm x 44cm x 93cm
PACKING : 2 PCS/CTN



Z-235-01 GX-032E-G 3 TIER PLASTIC COLLECTOR TROLLEY (GREY) –
 SIZE : 104cm x 46cm x 91cm
 PACKING : 1PCS/CTN



Z-235-02 GX-032E-B 3 TIER PLASTIC COLLECTOR TROLLEY (BLACK) –
 SIZE : 104cm x 46cm x 91cm
 PACKING : 1PCS/CTN

ACCESSORIES



- **Z-235-03** GX-068B 4 CASE CUTLERY TRAY –
 SIZE : 52cm x 29.2 x 9.7cm
 PACKING : 24PCS/CTN
- **Z-235-04** GX-068G 4 CASE CUTLERY TRAY –
 SIZE : 53cm x 30.2 x 10cm
 PACKING : 12PCS/CTN
- **Z-235-05** GX-068BW 4 CASE CUTLERY TRAY –
 SIZE : 53cm x 30.2 x 10cm
 PACKING : 12PCS/CTN



Z-235-06 GX-035B MULTIPURPOSE PLASTIC BIN – SIZE : 33cm x 23cm x 17.5cm
 PACKING : 6 PCS/CTN



Z-235-07 GX-035A MULTIPURPOSE PLASTIC BIN –
 SIZE : 33cm x 23cm x 56cm
 PACKING : 6 PCS/CTN



Z-235-08 GX-036C COLLECTOR BIN –
 SIZE : 29cm x 21cm x 30cm
 PACKING : 4 PCS/CTN

SERVING TROLLEY



Z-236-01 GX-032DM LARGE MULTI-FUNCTION 3-SHELVES SERVING TROLLEY –
SIZE : **102cm x 50cm x 96cm**
PACKING : **1 PCS/CTN**



Z-236-02 GX-032G 3 LAYER PLASTIC SERVING TROLLEY –
SIZE : **50cm x 32cm x 72cm**
PACKING : **1 PCS/CTN**



Z-236-03 GX-032H 3 LAYER ECONOMIC SERVING TROLLEY –
SIZE : **102cm x 50cm x 96cm**
PACKING : **1 PCS/CTN**



- **Z-236-04** 328A-G 3 TIER ROUND TUBE PLASTIC SERVING TROLLEY (GREY) –
SIZE : **107cm x 51cm x 97cm**
PACKING : **1 PCS/CTN**
- **Z-236-05** 328B-G 3 TIER ROUND TUBE PLASTIC SERVING TROLLEY (GREY) –
SIZE : **83.5cm x 43cm x 97cm**
PACKING : **1 PCS/CTN**



- **Z-236-06** 328A-B 3 TIER ROUND TUBE PLASTIC SERVING TROLLEY (BLACK) –
SIZE : **107cm x 51cm x 97cm**
PACKING : **1 PCS/CTN**
- **Z-236-07** 328B-B 3 TIER ROUND TUBE PLASTIC SERVING TROLLEY (BLACK) –
SIZE : **83.5cm x 43cm x 97cm**
PACKING : **1 PCS/CTN**

RUBBISH BIN



- **Z-237-01 GX002-B 58L RUBBISH BIN (BLUE) - PACKING : 1 PCS/CTN**
- **Z-237-02 GX002-G 58L RUBBISH BIN (GREEN) - PACKING : 1 PCS/CTN**
- **Z-237-03 GX002-R 58L RUBBISH BIN (RED) - PACKING : 1 PCS/CTN**
- **Z-237-04 GX002-GY 58L RUBBISH BIN (GREY) - PACKING : 1 PCS/CTN**



- **Z-237-05 BP120 MOBILE GARBAGE BINS –
SIZE : W 47cm x D 56cm x H 95.5cm
Capacity : 120 L**
- **Z-237-06 BP240 MOBILE GARBAGE BINS –
SIZE : W 57cm x D 73cm x H 104cm
Capacity : 240 L**



- **Z-237-07 BP1100 MOBILE GARBAGE BINS –
SIZE : W 125cm x D 106cm x H 135cm
Capacity : 1100 L**



- **Z-238-01** GX-803 68L FOOT PEDAL TRASH BIN –
SIZE: **50cm x 41cm x 66cm**
PACKING : **5 PCS/CTN**
- **Z-238-02** GX-804 87L FOOT PEDAL TRASH BIN –
SIZE: **50cm x 41cm x 81cm**
PACKING : **5 PCS/CTN**



- **Z-238-03** FIBER BLACK DUSTBIN – Capacity : **70 L**
- **Z-238-04** FIBER BLACK DUSTBIN – Capacity : **90 L**

BROOM & DUSTPAN



Z-239-01 KBM2030
BLACK PLASTIC BROOM –
PACKING : **100PCS/CTN**



Z-239-02 KBM9898(9980) FORTUNE
BROOM – PACKING : **12SETS/CTN**

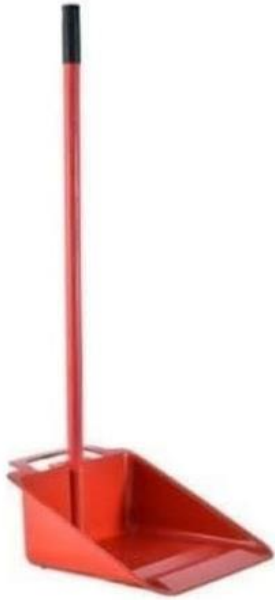

Z-239-03 DUSTPAN

MOP & WIPER



- **Z-240-01** 350A White Cotton Mop – SIZE : S
- **Z-240-02** 500A White Cotton Mop – SIZE : XL
- **Z-240-03** 600A White Cotton Mop – SIZE : XXL



Z-240-04 800Q-C/W Super Jumbo Mop
Cotton Without Handle – SIZE : XXL



Z-240-05 WIPER –
SIZE : L 440mm x W 50mm



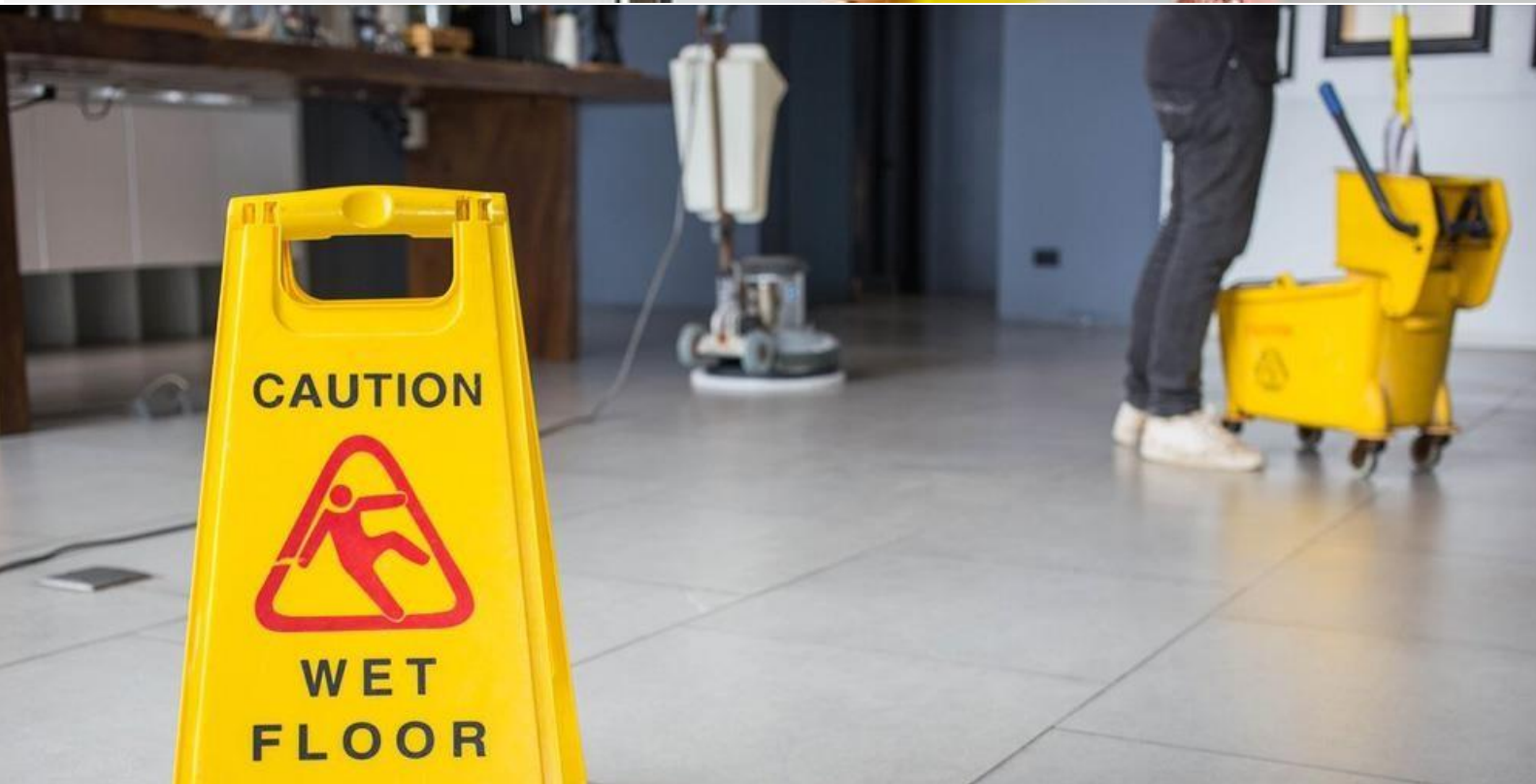

FLOOR CLEANING



Z-242-01 AF-038(E)
WARNING SIGN
(CLEANING IN PROGRESS)
– SIZE : L 32 cm x W 30 cm
x H 64 cm

Z-242-02 AF-041(E)
WARNING SIGN (OUT OF
SERVICE) – SIZE : L 32 cm
x W 30 cm x H 64 cm

Z-242-03 AF-042(E)
WARNING SIGN
(CAUTION WET FLOOR) –
SIZE : L 32 cm x W 30 cm
x H 64 cm

Z-242-04 AF-070H
TROLLEY WRINGER –
SIZE : L 25 cm x W 24 cm
x H 38.5 cm



Z-242-05 AF-068 (SMALL) WASHING TROLLEY –
SIZE : L 63 cm x W 27 cm x H 67 cm
Capacity : 20 litres

AF-068 Washing Trolley is a bucket with wringer that allows wring out a wet mop without dirty your hand. Wheels are present to allow for moving the trolley around with effortless of carrying a heavily bucket. The washing trolley with bright yellow colour bucket with safety caution sign visibility from far away and added safety. This AF-068 Washing Trolley ideal for restaurant, office but also great to use at home. Safety being priority, keeping excess water off and avoid slippery floor during mopping to create a safer environment for your family, employees or guests.

Comfortable Handle

- Premium tubular stainless steel with rubber tipped handle.

Swivel Caster

- Rolling wheel with water-resistant cover.

Down Press Wringer

- Enhanced wringer for not easily bent or cracked.



Z-243-01 AF-070 (BIG) WASHING TROLLEY –

SIZE : L 61 cm x W 42 cm x H 93 cm

Capacity : 35 litres

AF-070 Washing Trolley is a bucket with wringer that allows wring out a wet mop without dirty your hand. Wheels are present to allow for moving the trolley around with effortless of carrying a heavily bucket. The washing trolley with bright yellow colour bucket with safety caution sign visibility from far away and added safety. This AF-070 Washing Trolley ideal for restaurant, office but also great to use at home. Safety being priority, keeping excess water off and avoid slippery floor during mopping to create a safer environment for your family, employees or guests.

Comfortable Handle

- Premium tubular steel with rubber tipped wringer handle.

Swivel Caster

- Rolling wheel with water-resistant cover.

Sided Press Wringer

- Removable wringer, made of metal spring to provide more durable construction for longer lifespan.



Z-243-02 AF-710A WASHING TROLLEY WITH TWO BUCKETS –

SIZE : L 85 cm x W 44 cm x H 98 cm

Capacity : 23 litres x 2

AF-710A Washing Trolley is a bucket with wringer that allows wring out a wet mop without dirty your hand. Wheels are present to allow for moving the trolley around with effortless of carrying a heavily bucket. This AF-710A Washing Trolley designed with dual bucket for separating clean and dirty water. The front bucket keep fresh cleaning solution, while rear bucket keep soiled water direct from wringer. This AF-710A Washing Trolley ideal for hotel, hospital, school and commercial establishment, it helps to reduce amount of trips to make or to empty, rinse and replenish the bucket. Safety being priority, keeping excess water off and avoid slippery floor during mopping to create a safer environment.

Comfortable Handle

- Premium tubular handle with rubber tipped wringer handle.

Swivel Caster

- Pulling trolley with four 360° smooth rolling wheel.

Sided Press Wringer

- Removable wringer located above between dual buckets, separating clean and dirty water

VIP HANDTRUCK



- **Z-244-01 VI-150 VIP HANDTRUCK – SIZE : 725mm x 475mm x 830mm**
LOADING CAPACITY : **150 Kgs**
PACKING : **50 units/ pallet**
- **Z-244-02 VI-300 VIP HANDTRUCK – SIZE : 900mm x 595mm x 875mm**
LOADING CAPACITY : **300 Kgs**
PACKING : **50 units/ pallet**

HOW TO FOLD THE VIP HANDTRUCK ?

